



**Fios
Quantum
Gateway**

**USER
GUIDE**



CONTENTS

01/

INTRODUCTION

- 1.0 Package Contents 7
- 1.1 System Requirements 7
- 1.2 Features 7
- 1.3 Getting to Know Your Gateway 10

02/

CONNECTING YOUR GATEWAY

- 2.0 Setting Up Your Gateway 18
- 2.1 Computer Network Configuration 24
- 2.2 Main Screen 30

03/

WIRELESS SETTINGS

- 3.0 Overview 36
- 3.1 Wireless Status 37
- 3.2 Basic Security Settings 40
- 3.3 Advanced Security Settings 44
- 3.4 802.11 Mode 48
- 3.5 Other Advanced Wireless Options 49
- 3.6 Wi-Fi Channel Settings 53
- 3.7 Guest Wi-Fi Settings 56

04/

CONFIGURING MY NETWORK SETTINGS

- 4.0 Accessing My Network Settings 62
- 4.1 Using My Network Settings 63

05/

USING NETWORK CONNECTIONS

5.0	Accessing Network Connections	67
5.1	Network (Home/Office) Connection	68
5.2	Broadband Connection	75
5.3	Wireless Access Point Connection	79
5.4	Broadband Ethernet/Coax Connection	83

06/

CONFIGURING SECURITY SETTINGS

6.0	Firewall	91
6.1	Access Control	95
6.2	Port Forwarding	98
6.3	Port Triggering	100
6.4	DMZ Host	103
6.5	Remote Administration	104
6.6	Static NAT	106
6.7	Security Log	107

07/

SETTING PARENTAL CONTROLS

7.0	Activating Parental Controls	117
7.1	Rule Summary	120
7.2	Activating Advanced Parental Controls	121

CONTENTS

08/

CONFIGURING ADVANCED SETTINGS

8.0	Using Advanced Settings	125
8.1	Utilities	126
8.2	DNS Settings	140
8.3	Network Settings	144
8.4	Routing	150
8.5	Date and Time	174
8.6	Configuration Settings	179

09/

MONITORING YOUR GATEWAY

9.0	Gateway Status	186
9.1	Advanced Status	187
9.2	System Logging	188
9.3	Full Status/System wide Monitoring of Connections	189
9.4	Traffic Monitoring	190
9.5	Bandwidth Monitoring	191

10/

TROUBLESHOOTING

10.0	Troubleshooting Tips	194
10.1	Frequently Asked Questions	200

11/

SPECIFICATIONS

11.0	General Specifications	207
11.1	LED Indicators	208
11.2	Environmental Parameters	208

12/

NOTICES

12.0	Regulatory Compliance Notices	212
-------------	-------------------------------	------------

01/

INTRODUCTION

- 1.0** Package Contents
- 1.1** System Requirements
- 1.2** Features
- 1.3** Getting to Know Your Gateway

The Verizon Fios Quantum™ Gateway lets you transmit and distribute digital entertainment and information to multiple devices in your home/office.

Your Gateway supports networking using coaxial cables, Ethernet, or Wi-Fi, making it one of the most versatile and powerful gateways available.

PACKAGE CONTENTS, SYSTEM REQUIREMENTS AND FEATURES

1.0/ PACKAGE CONTENT

Your package contains:

- The Fios Quantum Gateway
- Power adapter
- LAN Ethernet cable (yellow)
- WAN Ethernet cable (white)
- Quick Start Guide

1.1/ SYSTEM REQUIREMENTS

System and software requirements are:

- A computer or other network device supporting Wi-Fi or wired Ethernet
- A web browser, such as Chrome™, Firefox®, Internet Explorer 10® or higher, or Safari® 5.1 or higher

1.2/ FEATURES

Your Gateway features include:

- Support for multiple networking standards, including
 - WAN – Gigabit Ethernet and MoCA 2.0 interfaces
 - LAN – 802.11 b/g/n/ac, Gigabit Ethernet and MoCA 2.0 interfaces
- Integrated wired networking with 4-port Ethernet switch and Coax (MoCA)

-
- Ethernet supports speeds up to 1000 Mbps
 - MoCA 2.0 and 1.1 enabled to support speeds up to 700 Mbps over coaxial cable
 - Integrated wireless networking with 802.11b/g/n/ac access point featuring:
 - Enabled 802.11b capable speeds (based on device)
 - Enabled 802.11g capable speeds (based on device)
 - Enabled 802.11n capable speeds (based on device)
 - Enabled 802.11ac capable speeds (based on device)
 - Enterprise-level security, including:
 - Fully customizable firewall with Stateful Packet Inspection (SPI)
 - Content filtering with URL-keyword based filtering, parental controls, and customizable filtering policies per computer
 - Intrusion detection with Denial of Service protection against IP spoofing attacks, scanning attacks, IP fragment overlap exploit, ping of death, and fragmentation attacks
 - Event logging
 - Static NAT
 - Port forwarding

FEATURES AND GETTING TO KNOW YOUR GATEWAY

- Port triggering
- Access control
- Advanced wireless protection featuring WPA2, WPA2/WPA Mixed Mode and WEP 64/128 bit encryption
- Options, including:
 - DHCP server
 - WAN interface auto-detection
 - Dynamic DNS
 - DNS server
 - LAN IP and WAN IP address selection
 - MAC address cloning
 - IPv6 support
 - QoS support (end-to-end layer 2/3) featuring: Differentiated Services (Diffserv), 802.1p/q prioritization, and pass-through of WAN-side DSCPs, Per Hop Behaviors (PHBs), and queuing to LAN-side devices
 - Remote management and secured remote management using HTTPS
 - Static routing
 - VPN (VPN pass through only)
 - IGMP
 - Daylight savings time support

1.3/ GETTING TO KNOW YOUR GATEWAY

1.3a/ FRONT PANEL

The front panel has two lighted indicators and a WPS (Wi-Fi Protected Setup) button.

The Power/Internet light will be on and solid white when your Gateway is turned on, connected to the Internet, and functioning normally.

The Wireless light will be on when your Gateway Wi-Fi is turned on.

For additional information on the front lights and error indications, refer the **Troubleshooting** section in this guide.

The WPS button is used to initiate Wi-Fi Protected Setup. This is an easy way to add WPS capable devices to your wireless network.

When WPS is initiated from your Gateway, the wireless light slowly flashes white for up to two minutes, allowing time to complete the WPS pairing process on your wireless device (also known as a wireless client).

When a device begins connecting to your Gateway using WPS, the wireless light rapidly flashes white for a few seconds, then turns solid white as the connection completes.

If there is an error during the WPS pairing process, the wireless light flashes red rapidly for two minutes after the error occurs.



GETTING TO KNOW YOUR GATEWAY

The WPS button can also be used to reboot the router. To perform a soft reboot, press and hold the WPS button for at least 10 seconds.

1.3b/ SIDE PANEL

The side panel of your Gateway has a label that contains important information about your device, including the default settings for the Gateway’s wireless network name (ESSID), wireless password (WPA2 key), local URL for accessing the Gateway’s administrative pages, and Gateway administrator password. The label also contains a QR code that you can scan with your smartphone, tablet, or other camera-equipped Wi-Fi device to allow you to automatically connect your device to your Wi-Fi network without typing in a password (requires a QR code reading app with support for Wi-Fi QR codes).



Note: Image may vary depending on your configuration.

1.3c/ REAR PANEL

The rear panel of your Gateway has 8 ports; COAX, Ethernet LAN [4], Ethernet WAN, and USB [2]. The rear panel also includes a DC power jack and a reset button.

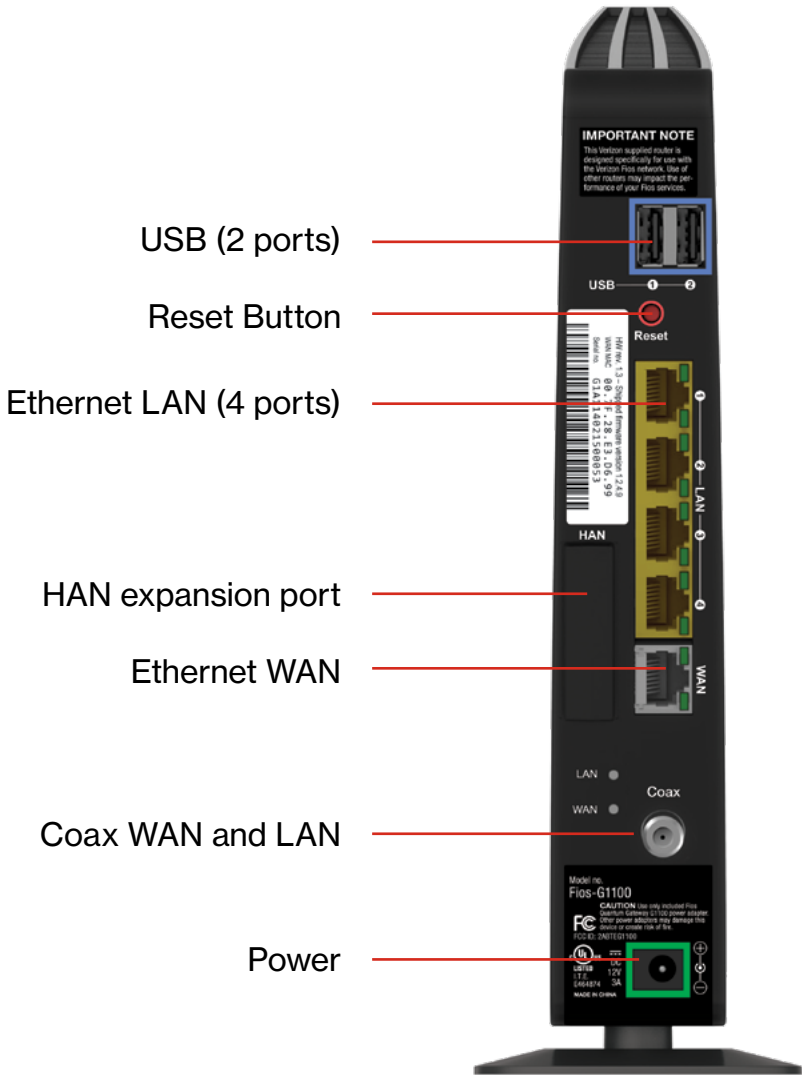

GETTING TO KNOW YOUR GATEWAY

- **USB** - provides up to 500 mA at 5 VDC for attached devices. For example, you could charge a cell phone. In the future, with a firmware upgrade, the USB host functionality may be available for other devices, such as external storage and cameras. Firmware updates are performed automatically by Verizon.
- **Reset Button** - allows you to reset your Gateway to the factory default settings. To reset the Gateway, press and hold the Reset button for at least three seconds.
- **Ethernet LAN** - connects devices to your Gateway using Ethernet cables to join the local area network (LAN). The four Ethernet LAN ports are 10/100/1000 Mbps auto-sensing and can be used with either straight-through or crossover Ethernet cables.
- **HAN Expansion Port** - provides for future hardware upgrades to add support for Home Area Networking capabilities.
- **Ethernet WAN** - connects your Gateway to the Internet using an Ethernet cable.
- **Coax WAN and LAN** - connects your Gateway to the Internet and/or to other MoCA devices using a coaxial cable.

Warning: The WAN Coax Port is intended for connection to Verizon Fios only. It must not be connected to any exterior or interior coaxial wires not designated for Verizon Fios.

- **Power** - connects your Gateway to an electrical wall outlet using the supplied power adapter.

Warning: The included power adapter is for home use only, supporting voltages from 100-240Vac. Do not use in environments with greater than 240Vac.

1.3d/ MOUNTING THE GATEWAY TO A WALL

For optimum performance, the Fios Quantum Gateway is designed to stand in a vertical upright position. Verizon does not recommend wall mounting the Fios Quantum Gateway. However, if you wish to mount your Gateway, you can purchase a wall mount bracket from the Verizon Fios Accessories Store at verizon.com/fiosaccessories.

If you are replacing an existing Verizon wall mounted router, you do not need to remove the mounting screws from the wall. The existing mounting screws will fit the new bracket.

To mount your Gateway to a wall:

1. Remove the foot by turning the Gateway upside down and removing the single screw that holds the foot to the Gateway.



2. Slide the foot toward the front of the Gateway and pull the foot from the holes. You may need to wiggle the foot slightly.
3. You may use the wall mount bracket as a template for positioning the Gateway.

GETTING TO KNOW YOUR GATEWAY

4. Mark the mounting holes, then remove the wall mount bracket from the wall.
5. Drill holes for the screw anchors.
6. Insert the screw anchors in the holes in the wall, then insert the screws into the screw anchors and tighten the screws. Leave screws extended about 0.2 inches from the wall.
7. Verify the screws are positioned correctly by placing the wall bracket on the screws. Remove the wall bracket from the wall.
8. Place the Gateway on the wall bracket and slide the Gateway forward until it locks in place.

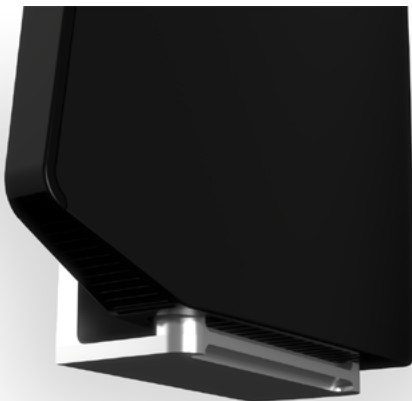

9. To secure the Gateway, attach the bracket to the Gateway using the single screw you removed from the foot.
10. Slide the wall mount bracket with the attached Gateway on the screws, then slide the bracket down until it locks in place.

02/

CONNECTING YOUR GATEWAY

2.0 Setting Up Your Gateway

2.1 Computer Network
Configuration

2.2 Main Screen

SETTING UP YOUR GATEWAY

Connecting your Gateway and accessing its web-based Graphical User Interface (GUI) are both simple procedures.

Accessing the GUI may vary slightly, depending on your device's operating system and web browser.

2.0/ SETTING UP YOUR GATEWAY

There are three basic steps to setting up your Gateway:

- Step 1:** Connect your Gateway to the Internet
- Step 2:** Connect your network device to your Gateway
- Step 3:** Configure your Gateway

Before you begin, if you are replacing an existing Gateway, disconnect it. Remove all old Gateway components, including the power supply. They will not work with your new Gateway.

2.0a/ STEP 1 - CONNECT YOUR GATEWAY

1. Remove your Gateway, Ethernet cables, and power adapter from the box.
2. Locate your high-speed Internet (WAN) outlet. This would be the wall jack installed previously by Verizon. Note the type of jack may be either Ethernet or coaxial.
3. Connect your Gateway to the Internet (WAN).
 - If connecting the WAN using Ethernet, use the supplied white Ethernet cable and plug one end into the white Ethernet WAN port on the back of your Gateway. Plug the other end of the cable into the high-speed Ethernet wall jack.



SETTING UP YOUR GATEWAY

- If connecting the WAN using coaxial cable, locate a coaxial cable and connect one end to the coax port on the back of your Gateway. Connect the other end of the coaxial cable to a coax wall jack.

Tighten the coaxial cables by hand until snug. The cables should not require a wrench.



4. Plug the power cord into the power port on the back of your Gateway and then into a power outlet. The Gateway automatically turns on as soon as power is plugged in.

***Important:** Wait until the Power/Internet light on the front of the Gateway stops flashing and is solid white. If the light turns red, check the trouble-shooting steps in the Troubleshooting section of the user guide.*

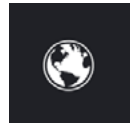

2.0b/ STEP 2 - CONNECT YOUR DEVICE TO YOUR GATEWAY

Connecting a device using wired Ethernet (preferred for initial setup):

- Plug one end of the supplied yellow Ethernet cable into one of the four yellow Ethernet ports in the back of your Gateway. Alternatively, you can use your own Ethernet cable of any color to connect from the yellow Ethernet ports on the back of your Gateway to your device with an Ethernet connector.
- Plug the other end of the yellow Ethernet cable into the Ethernet port of your network device.

If connecting a wireless device:

- Access the Wi-Fi setting on your wireless device, then select your new Gateway using the wireless network name (ESSID) shown on the sticker located on the side of your Gateway.
- Enter the wireless password (WPA2 key) also shown on the sticker.



Note: Image may vary depending on your configuration.

2.0c/ STEP 3 - CONFIGURE YOUR GATEWAY:

1. Open a web browser on the device connected to your Gateway network.
2. In the browser address field (URL), enter: **myfiosgateway.com**, then press the **Enter** key on your keyboard.

Alternately, you can enter: **https://192.168.1.1**

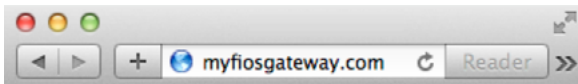

SETTING UP YOUR GATEWAY

The first time you access your Gateway, an Easy Setup Wizard displays to help step you through the setup process.



Welcome to your Fios Quantum Gateway!

Let's get started with Wi-Fi setup in 3 easy steps!

Step 1 Please log in to your router

Enter the Admin Password located on the side of your router.

Admin Password: ?
 Show Password

Next > Cancel and perform later >



Note: Some setup images may vary depending on your configuration.

3. In the **Admin Password** field, enter the password that is printed next to the Administrator Password on the label on the side of your Gateway.



Note: Image may vary depending on your configuration.

4. Click **Next**. The Personalize Your Wi-Fi Settings screen displays. Click on the check box next to **Setup your Guest Wi-Fi (Optional)** to personalize your Guest Wi-Fi Name and Password.

fios
by verizon

Welcome to your Fios Quantum Gateway!

Step 2 Personalize your Wi-Fi settings

Your router is pre-configured with the Wi-Fi settings below. You may use the defaults or change the name and password to something easier to remember.

Wi-Fi Name: ?

Wi-Fi Password: ?

Wi-Fi Password must be at least 8 characters.

[Restore defaults >](#)

[Restore from Account >](#)

Setup and enable your Guest Wi-Fi (Optional):

To keep your Wi-Fi secure, the Fios Quantum Gateway has the ability to create a Guest Wi-Fi network, where your guests can access the internet but will not have access to your private files, shared printers and media.

Guest Wi-Fi Name:

Guest Wi-Fi Password: ?

Guest Wi-Fi Password must be at least 8 characters.

Create Guest Wi-Fi without a password (not recommended)

[Continue >](#) [Cancel and perform later >](#) [< Back](#)

Note: Some setup images may vary depending on your configuration.

For your protection, your Gateway is pre-set at the factory to use WPA2 (Wi-Fi Protected Access) encryption for your wireless network. This is the best setting for most users and provides maximum security.

SETTING UP YOUR GATEWAY AND COMPUTER NETWORK CONFIGURATION

5. Click **Continue**. The Apply to Save Your Wi-Fi Settings screen appears. You have an option of saving the Wi-Fi settings as an image on your device by clicking the **Save as Picture** button. After you click **Save as Picture** to save your Wi-Fi settings as an image, click **Apply** to save the Wi-Fi changes to your Gateway.

Important: If you are on a Wi-Fi device when setting up your Gateway, you will be disconnected from the Wi-Fi network when you change the Wi-Fi name or Wi-Fi password. When this occurs, your Gateway will detect this situation and prompt you to reconnect using the new settings.



Welcome to your Fios Quantum Gateway!

Step 3 Review and Apply your Wi-Fi settings:

Wi-Fi Name: FIOS-AB1CD

Wi-Fi Password: sample123456password

Guest Wi-Fi: On

Guest Wi-Fi Name: Fios-AB1CD-Guest

Guest Wi-Fi Password: Guest123password

[Restore default settings >](#)

You can add devices in one simple step. If your device has WPS, then simply press the WPS button on the router & on your device. They will automatically and securely connect.

Don't forget to download the **My Fios App**, which allows you to manage your router remotely, enable and manage parental controls, manage your guest network and provides additional ways to add devices.

You can download My Fios App from the [Google Play Store](#) or [Apple App Store](#).



[Apply >](#)

[Cancel and perform later >](#)

[Save as picture >](#)

[< Back](#)

The Congratulations! You're All Set Up screen displays once your Gateway verifies the final settings and has successfully connected to the Internet and is ready for use. You can click on **Main Router Settings** to access the Main screen of the Gateway or click on **Start Browsing** and you will be directed to the Verizon.com website.



Welcome to your Fios Quantum Gateway!

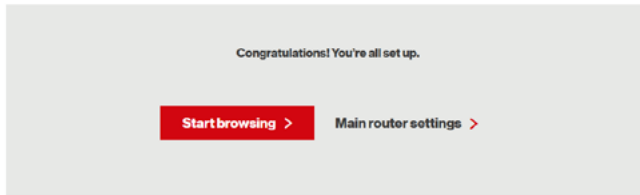

If your Gateway is subsequently reset to the factory default settings, the settings printed on the label will again be in effect.

If your Gateway fails to connect, follow the troubleshooting steps in the **Troubleshooting** section of this guide.

2.1/ COMPUTER NETWORK CONFIGURATION

Each network interface on your computer should either automatically obtain an IP address from the upstream Network DHCP server (default configuration) or be manually configured with a statically defined IP address and DNS address. We recommend leaving this setting as is.

COMPUTER NETWORK CONFIGURATION

2.1a/ CONFIGURING DYNAMIC IP ADDRESSING

To configure a computer to use dynamic IP addressing:

WINDOWS 7/8/10

1. In the Control Panel, locate **Network and Internet**, then select **View Network Status and Tasks**.
2. In the **View your active networks – Connect or disconnect** section, click **Local Area Connection** in the **Connections** field. The Local Area Connection Status window displays.
3. Click **Properties**. The Local Area Connection Properties window displays.
4. Select **Internet Protocol Version 4 (TCP/IPv4)**, then click **Properties**. The Internet Protocol Version 4 (TCP/IPv4) Properties window displays.
5. Click the **Obtain an IP address automatically** radio button.
6. Click the **Obtain DNS server address automatically** radio button, then click **OK**.
7. In the Local Area Connection Properties window, click **OK** to save the settings.
8. To configure Internet Protocol Version 6 (TCP/IPv6) to use dynamic IP addressing, repeat step 1 to 7. However for step 3, select **Internet Protocol Version 6 (TCP/IPv6)** in the Properties option (refer to IPv6 section for Gateway configuration).

MACINTOSH OS X

1. Click the **Apple** icon in the top left corner of the desktop. A menu displays.
2. Select **System Preferences**. The System Preferences window displays.
3. Click **Network**.
4. Verify that Ethernet, located in the list on the left, is highlighted and displays **Connected**.
5. Click **Assist Me**.
6. Follow the instructions in the Network Diagnostics Assistant.

2.1b/ CONNECTING COMPUTERS & NETWORK DEVICES

You can connect your Gateway to other computers or set top boxes using an Ethernet cable, wireless connection (Wi-Fi) or coaxial cable.

ETHERNET

1. Plug one end of an Ethernet cable into one of the open yellow Ethernet ports on the back of your Gateway.
2. Plug the other end of the Ethernet cable into an Ethernet port on the computer.
3. Repeat these steps for each computer to be connected to your Gateway using Ethernet. You can connect up to four.

COMPUTER NETWORK CONFIGURATION

CONNECTING A WI-FI DEVICE USING WPS

Wi-Fi Protected Setup (WPS) is an easier way for many devices to set up a secure wireless network connection. Instead of manually entering passwords or multiple keys on each wireless client, such as a laptop, printer, or external hard drive, your Gateway creates a secure wireless network.

In most cases, this only requires the pressing of two buttons – one on your Gateway and one on the wireless client. This could be either a built-in button or one on a compatible wireless adapter/card, or a virtual button in software. Once completed, this allows wireless clients to join your wireless network.

To initialize the WPS process, you can either press and release the WPS button located on the front of your Gateway or use the GUI and press the on-screen button.

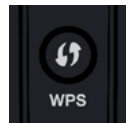

You can easily add wireless devices to your wireless network using the WPS option if your wireless device supports the WPS feature.

To access WPS using the user interface:

1. From the Main menu, select **Wireless Settings**, then select **Wi-Fi Protected Setup (WPS)**.

fios
by verizon

Main [Wireless Settings](#) [My Network](#) [Firewall](#) [Parental Controls](#) [Advanced](#) [System Monitoring](#)

Main >

[Wireless Status](#) >

[Basic Security Settings](#) >

[Advanced Security Settings](#) >

[Wi-Fi Channel Analyzer](#) >

[Guest Wi-Fi Settings](#) >

[Wi-Fi Protected Setup \(WPS\)](#) >

[Logout](#) >

Wi-Fi Protected Setup (WPS)

Wi-Fi Protected Setup is an easy way to add wireless devices to your network. To use this feature, your wireless client device needs to support WPS.

Warning: Wireless devices may briefly lose connectivity when turning WPS ON or OFF

Wi-Fi Protected Setup: OFF ON

You have two alternate methods to add a wireless device to your network using WPS:

1 Push button configuration (preferred):
If your client device has a WPS button, press it and then click the button below to start WPS registration.

WPS >

OR

2 PIN enrollment:
If your client device has a WPS PIN, enter that number below (usually found on a sticker on the back of the device) and click "Register":

Client WPS PIN: **Register >**

Alternatively, If your client supports it, enter the router's PIN into the client device:

Enable router's PIN 27342190

2. Enable the protected setup by moving the selector to On.
3. Use one of the following methods:
 - If your wireless client device has a WPS button, press the WPS button on your Gateway, then click the WPS button on your wireless device (client) to start the WPS registration process.
 - If your client device has a WPS PIN, locate the PIN printed on the client's label or in the client documentation.

COMPUTER NETWORK CONFIGURATION AND MAIN SCREEN

Enter the PIN number in the **Client WPS PIN** field. The **Client WPS PIN** field is located in the section **2 - PIN Enrollment** on the user interface.

Click **Register**. Alternatively, you can enter the Gateway's PIN shown on this screen into the WPS user interface of your device, if this PIN mode is supported by your wireless device.

4. After pressing the WPS button on your Gateway, you have two minutes to press the WPS button on the client device before the WPS session times out.

When the WPS button on your Gateway is pressed, the Wireless light on the front of your Gateway begins flashing white. The flashing continues until WPS pairing to the client device completes successfully. At this time, the Wireless light turns solid white.

If WPS fails to establish a connection to a wireless client device within two minutes, the Wireless light on your Gateway flashes red for two minutes to indicate the WPS pairing process was unsuccessful. After flashing red, the light returns to solid white to indicate that Wi-Fi is on.

CONNECTING A WI-FI DEVICE USING A PASSWORD

1. Verify each device that you are connecting wirelessly (using Wi-Fi) has a built-in wireless or external wireless adapter.
2. Open the device's wireless settings application.
3. Select your Gateway's wireless network name (SSID) from

the device's list of discovered wireless networks.

4. When prompted, enter your Gateway's wireless password (WPA2 key) into the device's wireless settings. Your Gateway's default wireless network name and wireless password are located on the sticker on the side of your Gateway.
5. Verify the changes were implemented by using the device's web browser to access a site on the Internet.
6. Repeat these steps for every device that you are wirelessly connecting to your Gateway.

COAXIAL

1. Verify all coax devices are turned off.
2. Disconnect any adapter currently connected to the coaxial wall jack in the room where your Gateway is located.
3. Connect one end of the coaxial cable to the coaxial wall jack and the other end to the Coax port on your network device.
4. Power up the network device.

2.2/ MAIN SCREEN

When you log into your Gateway, the page displays showing the Main navigation menu at the top of the page and your Gateway's Status, including Quick Links, My Network, and Verizon Zone display in the body of the page.

MAIN SCREEN

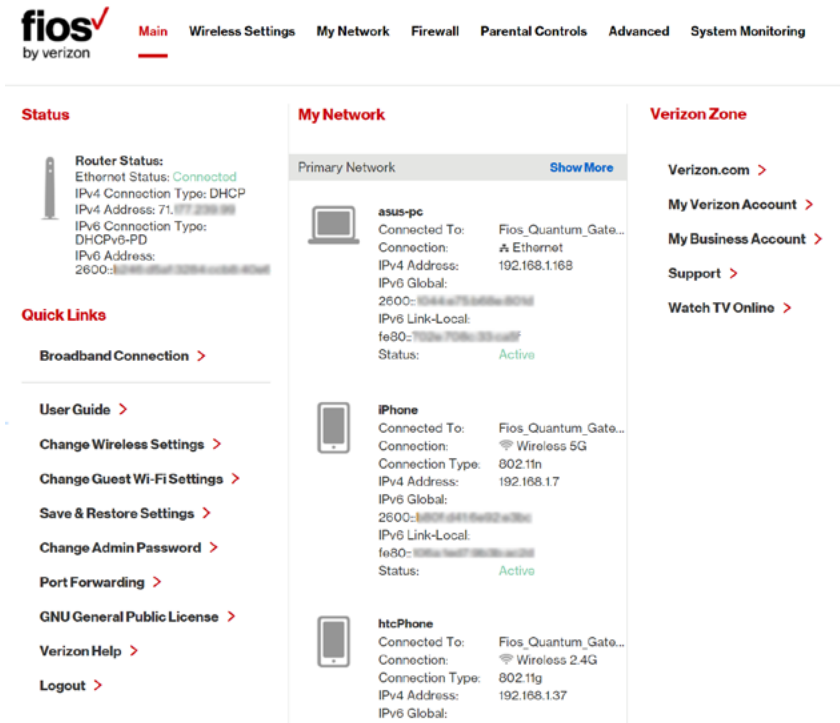

2.2a/ MENU

The Main menu links across the top of the page to the following configuration options and chapters:

- **Wireless Settings** - Chapter 3
- **My Network** - Chapter 5
- **Firewall** - Chapter 6
- **Parental Controls** - Chapter 7
- **Advanced** - Chapter 8

- **System Monitoring** - Chapter 9

2.2b/ STATUS

This section displays the status of your Gateway's local network (LAN) and Internet connection (WAN).

BROADBAND CONNECTION

Broadband Connection displays the state of the broadband connection:

- **Broadband interface:** Ethernet or Coax
- **Connected status:** Connected or No Connection
- **Connection Type:** DHCP or Static
- **WAN IP address:** Address of the broadband connection

QUICK LINKS

Quick Links contains frequently accessed documentation, such as User Guide and Verizon Help, and settings, such as Change Wireless Settings, Change Admin Password, and Port Forwarding as well as Logout.

MY NETWORK

My Network displays the connection type, IP address, and status of all devices that have accessed or are currently connected to the network.

MAIN SCREEN

The icon associated with the device displays to signify the device is active or shaded gray to indicate the device has not been active for several minutes. You can view the individual settings of each device by clicking its icon.

VERIZON ZONE

The Verizon Zone contains links to various Verizon web sites and other informational links.

Note: You may see an alert when using an older 802.11b device indicating the Wi-Fi network performance may be affected, as shown in the example below.

The screenshot shows the Fios by Verizon main screen. At the top, there is a navigation bar with the following items: **fios by verizon**, **Main** (underlined), **Wireless Settings**, **My Network**, **Firewall**, **Parental Controls**, **Advanced**, and **System Monitoring**.

Status

Router Status:
Ethernet Status: **Connected**
IPv4 Connection Type: DHCP
IPv4 Address: 71.177.238.88
IPv6 Connection Type: DHCPv6-PD
IPv6 Address: 2600:1000:1000:1000:1000:1000:1000:1000

Quick Links

- [Broadband Connection >](#)
- [User Guide >](#)
- [Change Wireless Settings >](#)
- [Change Guest Wi-Fi Settings >](#)
- [Save & Restore Settings >](#)
- [Change Admin Password >](#)
- [Port Forwarding >](#)
- [GNU General Public License >](#)
- [Verizon Help >](#)
- [Logout >](#)

My Network

Primary Network [Show More](#)

- TORAHML6R5GJX1**
Connected To: Fios_Quantum_Gate...
Connection: Wireless 2.4G
Connection Type: 802.11b ▲
IPv4 Address: 192.168.1.8
IPv6 Global: 2600:1000:1000:1000:1000:1000:1000:1000
IPv6 Link-Local: fe80::1000:1000:1000:1000
Status: **Active**
- HP-Printer**
Connected To: Fios_Quantum_Gate...
Connection: Ethernet
IPv4 Address: 192.168.1.10
IPv6 Global: 2600:1000:1000:1000:1000:1000:1000:1000
IPv6 Link-Local: fe80::1000:1000:1000:1000
Status: **Active**
- iPhone**
Connected To: Fios_Quantum_Gate...
Connection: Wireless 5G
Connection Type: 802.11n
IPv4 Address: 192.168.1.7

Network Warning

▲ 1 device on the network could be impacting WiFi performance, click here for more details.

Verizon Zone

- [Verizon.com >](#)
- [My Verizon Account >](#)
- [My Business Account >](#)
- [Support >](#)
- [Watch TV Online >](#)

03/

WIRELESS SETTINGS

- 3.0** Overview
- 3.1** Wireless Status
- 3.2** Basic Security Settings
- 3.3** Advanced Security Settings
- 3.4** 802.11 Mode
- 3.5** Other Advanced Wireless Options
- 3.6** Wi-Fi Channel Settings
- 3.7** Guest Wi-Fi Settings

OVERVIEW

Wireless networking enables you to free yourself from wires and plugs, making your devices more accessible and easier to use.

You can create a wireless network, including accessing and configuring wireless security options.

3.0/ OVERVIEW

Your Gateway provides you with wireless connectivity using the 802.11b, g, n, or ac standards. These are the most common wireless standards.

802.11b has a maximum data rate of 11 Mbps, 802.11g has a maximum data rate of 54 Mbps, 802.11n has a maximum data rate of 450 Mbps, and 802.11ac has a maximum data rate of 1300 Mbps.

802.11b and g standards operate in the 2.4 GHz range. 802.11n operates in both the 2.4 GHz and 5 GHz ranges. 802.11ac operates in the 5 GHz range.

Note: 802.11 b is a legacy mode and is not recommended. Even one 802.11b device connected to the network will slow your entire wireless network.

The wireless service and wireless security are activated by default. The level of security is preset to WPA2 encryption using a unique default WPA2 key (also referred to as a passphrase or password) pre-configured at the factory. This information is displayed on a sticker located on the side of your Gateway.

Your Gateway integrates multiple layers of security. These include Wired Equivalent Privacy (WEP), Wi-Fi Protected Access (WPA/WPA2), and firewall.



WIRELESS STATUS

Note: Image may vary depending on your configuration.

3.1/ WIRELESS STATUS

Use the Wireless Status feature to view the status of your Gateway's wireless network.

To view the status:

1. Access the Main page. You can quickly view the status of all your wireless and wired devices in the My Network column. This includes all devices that have recently accessed or are currently connected to the network.

fios by verizon

[Main](#) [Wireless Settings](#) [My Network](#) [Firewall](#) [Parental Controls](#) [Advanced](#) [System Monitoring](#)

Status

Router Status:
Ethernet Status: Connected
IPv4 Connection Type: DHCP
IPv4 Address: 71.197.132.100
IPv6 Connection Type: DHCPv6-PD
IPv6 Address: 2600:1000:1000:1000:1000:1000:1000:1000

Quick Links

- [Broadband Connection >](#)
- [User Guide >](#)
- [Change Wireless Settings >](#)
- [Change Guest Wi-Fi Settings >](#)
- [Save & Restore Settings >](#)
- [Change Admin Password >](#)
- [Port Forwarding >](#)
- [GNU General Public License >](#)
- [Verizon Help >](#)
- [Log out >](#)

My Network

Primary Network [Show More](#)

- asus-pc**
Connected To: Fios_Quantum_Gate...
Connection: Ethernet
IPv4 Address: 192.168.1.168
IPv6 Global: 2600:1000:1000:1000:1000:1000:1000:1000
IPv6 Link-Local: fe80::1000:1000:1000:1000
Status: Active
- iPhone**
Connected To: Fios_Quantum_Gate...
Connection: Wireless 5G
Connection Type: 802.11n
IPv4 Address: 192.168.1.17
IPv6 Global: 2600:1000:1000:1000:1000:1000:1000:1000
IPv6 Link-Local: fe80::1000:1000:1000:1000
Status: Active
- htcPhone**
Connected To: Fios_Quantum_Gate...
Connection: Wireless 2.4G
Connection Type: 802.11g
IPv4 Address: 192.168.1.37
IPv6 Global: 2600:1000:1000:1000:1000:1000:1000:1000
IPv6 Link-Local: fe80::1000:1000:1000:1000
Status: Active

Verizon Zone

- [Verizon.com >](#)
- [My Verizon Account >](#)
- [My Business Account >](#)
- [Support >](#)
- [Watch TV Online >](#)

2. Select the **Wireless Settings** icon. The Wireless Status page displays additional wireless details.

The screenshot shows the Fios by Verizon website interface. The top navigation bar includes: Main, **Wireless Settings** (underlined), My Network, Firewall, Parental Controls, Advanced, and System Monitoring. The left sidebar contains a menu with the following items: Main >, Wireless Status >, Basic Security Settings >, Advanced Security Settings >, Wi-Fi Channel Settings >, Guest Wi-Fi Settings >, Wi-Fi Protected Setup (WPS) >, and Logout >. The main content area is titled "Self-Organizing Network Status" and contains the following settings:

Band Steering Enabled:	Yes
Access Point Steering Enabled:	No

2.4 GHz Wireless Status

Radio Enabled:	Yes
SSID:	Fios-AB1CD
Channel Selection:	Automatic
Current Channel:	11
Channel Width:	20 MHz
Security Enabled:	Yes
WPA2:	sample123456password
SSID Broadcast:	Enabled
Wireless Mode:	Compatibility Mode(802.11b/g/n)
WMM:	Enabled
Received Packets:	538
Sent Packets:	566

5 GHz Wireless Status

Radio Enabled:	Yes
SSID:	Fios-AB1CD
Channel Selection:	Automatic
Current Channel:	44
Channel Width:	80 MHz
Security Enabled:	Yes

Note: Image may vary depending on your configuration.

WIRELESS STATUS AND BASIC SECURITY SETTINGS

3. On the Wireless Status page for either 2.4 GHz or 5 GHz, the following information displays:
 - **Self-Organizing Network (SON)** - supports client Band Steering and Load Balancing. Access Point steering supported when a qualified extender is connected on the network.
 - **Radio Enabled** - displays whether the wireless radio is active. When the radio is not enabled, no wireless devices will be able to connect to the home network.
 - **SSID** - displays the SSID (Service Set Identifier) shared among all devices on a wireless network. The SSID is the network name. All devices must use the same SSID.
 - **Channel Selection** - displays the type of wireless channel currently selected (Automatic or Manual)
 - **Current Channel** - displays the channel the wireless connection is currently using.
 - **Channel Width** - displays how much bandwidth the radio is using.
 - **Security Enabled** - displays the type of security active on the wireless connection as well as the security encryption key.
 - **SSID Broadcast** - displays whether your Gateway is broadcasting its SSID. If activated, the SSID of your Gateway wireless network is broadcast wirelessly. If not activated, the SSID is hidden and the wireless clients must be manually configured to use the SSID.

- **Wireless Mode** - displays the types of wireless device that can join the network.
- **WMM** - displays if WMM is enabled on your Gateway.
- **Packets Received/Sent** - displays the number of packets received and sent since the wireless capability was activated.

3.2/ BASIC SECURITY SETTINGS

You can configure the basic security settings for your Gateway's wireless network.

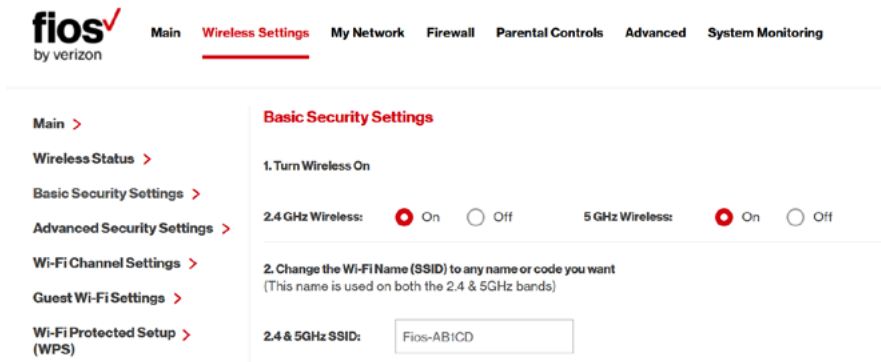

Note: Image may vary depending on your configuration.

To configure the basic security radio, SSID and channel settings:

1. On the Wireless Setting page, select **Basic Security Settings**.

BASIC SECURITY SETTINGS

2. To activate the wireless radio, click the **On** radio button.
3. If desired, enter a new name for the wireless network in the **SSID** field or leave the default name that displays automatically.

To configure the basic Wi-Fi Security settings, select a Security option:

3. Wi-Fi Security
Securing your Wi-Fi traffic as it transmits through the air, we recommend you use WPA2 security, unless you experience compatibility issues.

Risk Level	2.4 GHz Security	5 GHz Security
Low	<input checked="" type="radio"/> WPA2	<input checked="" type="radio"/> WPA2
Medium	<input type="radio"/> WPA2/WPA mixed mode	<input type="radio"/> WPA2/WPA mixed mode
High	<input type="radio"/> WEP	
High	<input type="radio"/> None	<input type="radio"/> None

Note: Image and available settings may vary depending on your configuration.

WPA/WPA2 Mixed Mode

If WPA/WPA2 Mixed Mode (Wi-Fi Protected Access) was selected, the WPA Key page displays. Selecting WPA/WPA2 Mixed Mode allows the security mode to be automatically set by the gateway based on the security capabilities of the client device.

To set the WPA/WPA2 Mixed Mode security:

1. Enter the Pre-Shared Key as a wireless password.

Authentication Method: Wi-Fi Password

2.4 GHz Wi-Fi Password:

[? Tips for creating secure passwords](#)

2. Click **Apply** to save the changes.

Note: WPA/WPA2 Mixed Mode is not available when Self-Organizing Network (SON) is Enabled

WPA2

If WPA2 (Wi-Fi Protected Access II) was selected, the WPA2 page displays. WPA2 is the default wireless security protocol.

To set the WPA2 security:

1. Enter the new password.

Authentication Method: Wi-Fi Password

2.4 GHz Wi-Fi Password:

5 GHz Wi-Fi Password:

[? Tips for creating secure passwords](#)

2. Click **Apply** to save the changes.

WEP

If WEP was selected, the WEP Settings page displays.

BASIC SECURITY SETTINGS

Warning: WEP provides a low level of security and is not recommended. Additionally, the WEP security setting will drop your Gateway's wireless performance to a maximum data rate of 54 Mbps, and will disable Wi-Fi Protected Setup (WPS). WEP should only be enabled if you have wireless client devices that don't support WPA or WPA2.

Select a WEP Password

- To create a 64/40 WEP Hex Password, you need to enter a combination of 10 digits. You can choose any letter from A-F or any number from 0-9. Sample HEX WEP Password: 0FB310FF28.
- To create a 64/40 WEP ASCII, you need to enter a combination of 5 ASCII characters. Sample ASCII WEP Password: hello.
- To create a 128/104 WEP Hex Password, you need to enter a combination of 26 digits. You can choose any letter from A-F or any number from 0-9. Sample HEX WEP Password: 0FB310FF280FB310FF28123456.
- To create a 128/104 WEP ASCII, you need to enter a combination of 13 ASCII characters. Sample ASCII WEP Password: hellohello123.

Password Tips:

Use a mix of letters and numbers. Don't use personal information that could be guessed or easily discovered (for example, names of family members, birthdates, phone numbers)

2.4 GHz Wi-Fi

Select a WEP Password:

2.4 GHz Wi-Fi Password:

10 Digits Left

Note: Your Gateway's recommended wireless security encryption is set to WPA2. This is the factory default. WEP is not available when Self-Organizing Network (SON) is Enabled.

This section explains how to activate WEP (Wired Equivalent Privacy) wireless security. WEP is a significantly less robust security compared to WPA or WPA2 and is not recommended. To set up WPA2 wireless security, refer to the WPA2 section.

To configure basic security to WEP:

1. To turn on WEP (Wired Equivalent Privacy) security, click the **WEP** radio button.
2. Select a WEP security level as 64/40 bit or 128/104 bit.
3. Enter the key code. If using a HEX key, each character must be a letter from A to F or a number from 0 to 9. If the key is ASCII, each character can be either any ASCII or alphanumeric character.

If using 64/40 bit, enter 10 HEX or 5 ASCII/alphanumeric characters. If 128/104, enter 26 HEX or 13 ASCII/alphanumeric characters.

4. Be sure to write down the wireless settings for future use. Other wireless devices that will be connected to your Gateway must be configured to use these settings to join your Gateway's wireless network.
5. Click **Apply** to save changes.

3.3/ ADVANCED SECURITY SETTINGS

You can change your advanced wireless security settings, such as configuring wireless encryption to help protect your network from unauthorized access or damage to your network devices; disable your SSID broadcast to secure your wireless traffic; stop your Gateway from broadcasting your SSID; and change the wireless

BASIC SECURITY SETTINGS AND ADVANCED SECURITY SETTINGS

mode to limit or allow access to your wireless network based on the type of technology as well as other advanced wireless options.

To modify the security settings for either 2.4 GHz or 5 GHz:

1. In the Wireless Settings page, select **Advanced Security Settings**.

The screenshot shows the Fios by Verizon router settings interface. At the top, the navigation bar includes 'Main', 'Wireless Settings' (highlighted with a red underline), 'My Network', 'Firewall', 'Parental Controls', 'Advanced', and 'System Monitoring'. On the left side, a sidebar menu lists: 'Main >', 'Wireless Status >', 'Basic Security Settings >', 'Advanced Security Settings >', 'Wi-Fi Channel Settings >', 'Guest Wi-Fi Settings >', 'Wi-Fi Protected Setup (WPS) >', and 'Logout >'. The main content area is titled 'Advanced Security Settings' and contains two sections: 'Level 1:' with the description 'Stop your router from broadcasting your Wi-Fi Network Name (SSID). SSID Broadcast (Allows you to prevent users who do not know your SSID name to access your router wirelessly.)' and two radio buttons for '2.4 GHz SSID Broadcast' and '5 GHz SSID Broadcast'; and 'Level 2:' with the description 'Limit access to certain wireless devices' and a link for '802.11b/g/n/ac Mode (Allows you to limit access to your wireless network based on the type of technology.)' and another link for 'Other Advanced Wireless Options'.

3.3a/ LEVEL 1: SSID BROADCAST

You can configure your Gateway's SSID broadcast capabilities to allow or disallow wireless devices from automatically using a broadcast SSID name to detect your Gateway wireless network.

To enable or disable SSID broadcast:

1. In the Advanced Settings page, locate the **Level 1** section.

Level 1:

Stop your router from broadcasting your Wi-Fi Network Name (SSID).

SSID Broadcast (Allows you to prevent users who do not know your SSID name to access your router wirelessly.)

[2.4 GHz SSID Broadcast](#)[5 GHz SSID Broadcast](#)

2. Click the **2.4 GHz SSID Broadcast** or **5 GHz SSID Broadcast** link for the wireless network you wish to modify. The following example uses the 2.4 GHz network. The display configuration looks basically the same for the 5 GHz network.

2.4 GHz SSID Broadcast

When SSID Broadcast is enabled, it means that any computer or wireless device using the SSID of 'Any' can see your Router. To prevent this from happening, disable the SSID broadcast so that only those Wireless devices with your ESSID can access your Router.

Enable Disable

3. To enable SSID broadcasting, click the **Enable** radio button. SSID broadcast is enabled by default. The SSID of the wireless network will be broadcast to all wireless devices.
4. To disable SSID broadcasting, click the **Disable** radio button. The public SSID broadcast will be hidden from all wireless devices. You will need to manually configure additional wireless devices to join the wireless network.

ADVANCED SECURITY SETTINGS

5. Click **Apply** to save the changes.

3.3b/ LEVEL 2: LIMIT ACCESS

You can configure your Gateway to limit access to your wireless network by allowing access to devices based on the type of wireless technology used.

To limit access:

1. In the Advanced Settings page, locate the **Level 2** section.

Level 2:

Limit access to certain wireless devices

802.11b/g/n/ac Mode (Allows you to limit access to your wireless network based on the type of technology.)

Other Advanced Wireless Options

2. To limit access based on the type of technology, click the **802.11 b/g/n/ac Mode** link. The 802.11 b/g/n/ac Mode page displays. For additional details, refer to the **802.11 b/g/n/ac Mode** section.
3. To access other advanced wireless options, click the **Other Advanced Wireless Options** link. The Other Advanced Wireless Options page displays. For additional details, refer to the **Other Advanced Wireless Options** section.

3.4/ 802.11 MODE

From the 802.11 Mode page, you can limit the wireless access to your network by selecting the 2.4 GHz and 5 GHz wireless communication standard (mode) best suited or compatible with the devices you allow access to your wireless network.

The screenshot shows the fios by verizon interface. The navigation menu includes Main, **Wireless Settings**, My Network, Firewall, Parental Controls, Advanced, and System Monitoring. The left sidebar lists: Main >, Wireless Status >, Basic Security Settings >, Advanced Security Settings >, Wi-Fi Channel Settings >, Guest Wi-Fi Settings >, Wi-Fi Protected Setup (WPS) >, and Logout >. The main content area is titled **802.11 Mode** and contains the following text:

Access to the router's network can be restricted to wireless devices using unique modes on each band. This can be done for security reasons or to improve overall Wi-Fi network performance. Select the option that best applies to your wireless needs, then click Apply to save your settings.

The 2.4 GHz band allows all 802.11b/g/n devices by default but can limit access to :
802.11b/g (11/54Mbps) or
802.11n (450Mbps)

The 5 GHz band allows all 802.11n/ac devices by default but can limit access to:
802.11n (450Mbps) or
802.11ac (1300Mbps)

NOTE:
Theoretical wireless data rates listed above are based on the IEEE standard 802.11 specification. Performance from this AC1750 class router (450/1300) over the Wi-Fi interface will be dependent upon the WAN service speed, the capability and number of active client devices in use, distance from the router, and other interfering traffic and signals.

2.4 GHz Wireless Mode: ▼

5 GHz Wireless Mode: ▼

Apply > < Back

To select the 802.11 Mode:

1. On the Advanced Settings page, locate the Level 2 section and click the 802.11 Mode link. The 802.11 Mode page displays.

ADVANCED SECURITY SETTINGS

2. Select the 2.4 GHz Wireless Mode as follows:
 - **Compatibility** – This is the default mode setting, providing a good balance of performance and compatibility with existing wireless devices. 802.11b, g, and n devices can connect.
 - **Legacy** – For older wireless devices. Only 802.11b and g devices can connect. 802.11b (legacy mode) will cause your wireless network to slow and is not recommended.
 - **Performance** – For newer wireless 802.11n devices only. No other devices can be used.
3. Select the 5 GHz Wireless Mode as follows:
 - **N and AC Mode** – This is the default setting. Both 802.11n and 802.11ac are available on the 5 GHz frequencies.
 - **AC Only Mode** – This provides maximum performance. 802.11ac devices will have exclusive use of the 5 GHz frequencies and 802.11n devices will not be able to connect at 5 GHz.
4. Click **Apply** to save the changes.

3.5/ OTHER ADVANCED WIRELESS OPTIONS

You can view additional wireless options.

Comment: Recommend leaving defaults as is unless otherwise directed.

To view the options:

1. In the Advanced Settings page, locate the **Level 2** section and click **Other Advanced Wireless Options** link. A warning message displays.
2. Click **Yes**. The Other Advanced Wireless Options page displays.

The screenshot shows the fios by verizon wireless settings interface. At the top, there is a navigation bar with the following items: Main, **Wireless Settings** (highlighted with a red underline), My Network, Firewall, Parental Controls, Advanced, and System Monitoring. On the left side, there is a sidebar menu with the following items: Main >, Wireless Status >, Basic Security Settings >, Advanced Security Settings >, Wi-Fi Channel Settings >, Guest Wi-Fi Settings >, Wi-Fi Protected Setup (WPS) >, and Logout >. The main content area is titled "Self-Organizing Network Enabled:" and has a radio button set to "On". Below this, there are two sections: "2.4 GHz Advanced Wireless Options" and "5 GHz Advanced Wireless Options". Each section contains a checked checkbox for "Group Key Update Interval" with a value of 3600 and the unit "Seconds", and a "Transmit Power:" field with a value of 100 and the unit "%". Below each section is a link for "WMM Settings". At the bottom of the page, there are two buttons: "Apply >" and "< Back".

Note: Image may vary slightly depending on your configuration.

802.11 MODE AND OTHER ADVANCED WIRELESS OPTIONS

3. View the following options:

Caution: These settings should only be configured by experienced network technicians. Changing the settings could adversely affect the operation of your Gateway and your local network.

- **Self-Organizing Network (SON)** – supports client Band Steering and Load Balancing. Access Point steering supported when a qualified extender is connected on the network.
- **Group Key Update Interval** – time interval used to update the WPA2 shared key (used to generate the group key)
- **Transmit Power** – adjusts the power of the wireless signal

4. To access the WMM settings, click the **WMM Settings** link.

5. Click **Apply** to save changes.

3.5a/ WMM SETTINGS

You can prioritize the types of data transmitted over the wireless network using the advanced WMM settings.

Wireless QoS (WMM) also known as Wi-Fi Multimedia, can improve the quality of service (QoS) for voice, video, and audio streaming over Wi-Fi by prioritizing these data streams.

WMM Power Save can improve battery life on mobile Wi-Fi devices such as smart phones and tablets by fine-tuning power consumption.

WMM (Wi-Fi Multimedia) QoS and Power Save require a wireless client device which also supports WMM.

Note: The following example uses the 2.4 GHz network. The display configuration looks basically the same for the 5 GHz network.

To set the options:

1. In the Advanced Wireless Options page, click either the **2.4 GHz WMM Settings** link or the **5 GHz WMM Settings** link.

The screenshot shows the Fios by Verizon website interface. At the top left is the Fios by Verizon logo. A navigation bar contains links for Main, **Wireless Settings** (underlined), My Network, Firewall, Parental Controls, Advanced, and System Monitoring. On the left side, a sidebar menu lists: Main >, Wireless Status >, Basic Security Settings >, Advanced Security Settings >, Wi-Fi Channel Analyzer >, Guest Wi-Fi Settings >, Wi-Fi Protected Setup (WPS) >, and Logout >. The main content area is titled "2.4 GHz Wireless QoS (WMM)" and contains two settings: "Wireless QoS (WMM):" with a checked checkbox and the text "Enabled", and "WMM Power Save:" with a checked checkbox and the text "Enabled". At the bottom of the settings area are two buttons: a red "Apply >" button and a "Cancel >" link.

2. The WMM Settings page displays.
3. To enable Wireless QoS (WMM), select the **Enabled** check box.

OTHER ADVANCED WIRELESS OPTIONS

4. To enable WMM Power Save, enable **Wireless QoS (WMM)** first, then enable WMM Power Save by selecting the **Enabled** check box.
5. Click **Apply** to save changes.

3.6/ WI-FI CHANNEL SETTINGS

Using the Wi-Fi Channel Settings you can change a wireless channel, view the channel width; or perform an analysis of available 2.4 GHz or 5 GHz wireless channels.

To modify the Wi-Fi Channel settings for either 2.4 GHz or 5 GHz:

1. On the Wireless Setting page, select the Wi-Fi Channel Settings quick link. The Wi-Fi Channel Settings page displays.
2. To accept the default Automatic channel, or select the channel you want the wireless radio to use, select the **Keep my channel selection during power cycle** check box to save your channel selection when your Gateway is rebooted.
3. To include DFS Channels during channel scan, select the **Enable DFS Channels during Channel Scan** option and click on **Perform New Scan** (enabled by default). To disable DFS scan uncheck the DFS option.

Note: DFS channels are a subset of the 5GHz network that is shared with radar systems. Some consumer devices do not support these channels and cannot connect to routers that use them. Examples include some Roku and Amazon media

streaming devices. Disabling this feature will allow the router to select the best available channel to broadcast on and allow these devices to connect.

4. To view the Automatic Channel Change History (Date and Time) for the active 2.4 GHz and 5 GHz: bands, click on the 'View Channel history' button.

Comment: The following example only depicts the 2.4 GHz Channel Score & Channel Analysis, the display for the 5 GHz network looks similar.

4. Channel Score:

The router scans all available channels for a number of factors, such as the number of nearby Wi-Fi access points, their signal strength, and the interference these may cause. The router then uses these to rank and select the best available channel on each band at the time.

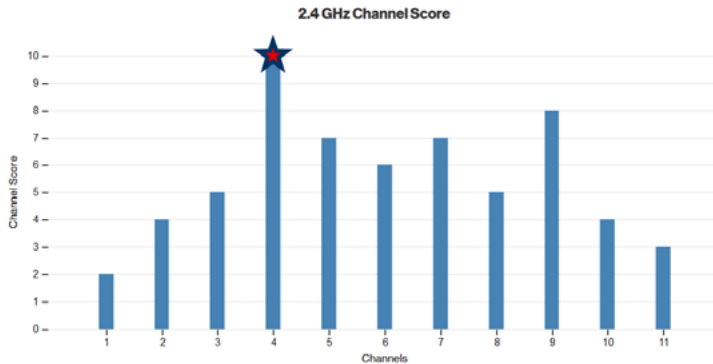

OTHER ADVANCED WIRELESS OPTIONS

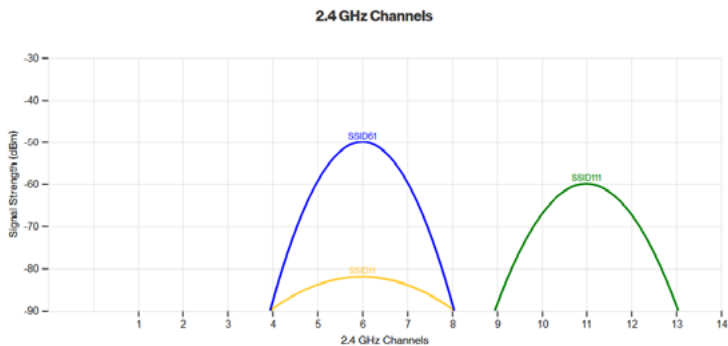

5. Select the desired wireless settings changes and click apply for the changes to take effect.

To modify the Wi-Fi Channel settings for either 2.4 GHz or 5 GHz:

- **Channel** - Defaults to Automatic, or shows your manual selection. To change the channel of the frequency band at which the Router communicates, select a channel from the drop-down menu. Then click apply to save your settings. On 5GHz, the range of DFS channels from 52-144 are excluded from manual selection.
- **Channel Width** (for 2.4 GHz Channel Width & 5 GHz Channel Width) - Channel frequencies are displayed in MHZ.
- **Channel Analyzer** (with Perform New Scan button) - Perform an analysis of the available channels for each band. Upon completion, the best channel will be automatically selected.
- **Channel Score** (Channel Chart Ranking) - The router scans all available channels for a number of factors, such as the number of nearby Wi-Fi access points, their signal strength, and the

interference these may cause. The router then uses these to rank and select the best available channel on each band at the time.

Note: manual channel selection cause Channel Score data to be removed, switching back to Automatic and performing a new scan will populate the results.

- **Channel Analysis** (with Signal Strength Graph) – The router scans all available channels for Access Points which are broadcasting on a channel(s) and their signal strength. Note: manual channel selection (in either band) will cause Channel Analysis data to be removed, switching back to Automatic and performing a new scan will populate the results.

3.7/ GUEST WI-FI SETTINGS

The Guest Wi-Fi network is designed to provide Internet connectivity to your guests but restricts access to your primary network and shared files. The primary network and the guest network are separated from each other through firewalls. You create one Guest Wi-Fi SSID and one password and use it for all guests. Guest Wi-Fi can be managed using either the Gateway's web interface, or via the Verizon My Fios app. The guest network SSID does not change when you make a change to your primary network SSID.

The Gateway is shipped from the factory with Guest Wi-Fi turned off. The default SSID for Guest Wi-Fi is preconfigured at the factory to the default wireless network name (ESSID) which is displayed on a sticker located at the side of the router followed by hyphen guest (-Guest). For example – if the router is shipped with a default SSID of “Fios-ABCDE” then the default SSID for Guest Wi-Fi is “Fios-ABCDE-Guest”.

GUEST WI-FI SETTINGS

The screenshot shows the Fios by Verizon router settings interface. At the top, the navigation menu includes: Main, **Wireless Settings** (underlined), My Network, Firewall, Parental Controls, Advanced, and System Monitoring. On the left, a sidebar menu lists: Main >, Wireless Status >, Basic Security Settings >, Advanced Security Settings >, Wi-Fi Channel Analyzer >, Guest Wi-Fi Settings >, Wi-Fi Protected Setup (WPS) >, and Logout >. The main content area is titled "Guest Wi-Fi Settings" and has two tabs: "Guest Devices" and "Guest Wi-Fi" (which is selected and underlined). Under the "Guest Wi-Fi" tab, there is a toggle switch for "Guest Wi-Fi" set to "ON". Below this, the "SSID" is "FIOS-AB1CD-Guest" and the "Password" is masked with dots. There is a checkbox for "Show Password" which is currently unchecked. At the bottom, it says "Connected Guest Devices: 2" and there is a red "Edit >" button.

3.7a/ GUEST WI-FI

To enable Guest Wi-Fi:

1. From the Main menu, select Wireless Settings, then select Guest Wi-Fi Settings
2. Select the Guest Wi-Fi tab
3. Press the Edit button and enter a valid SSID and password
4. Press **Save** to save changes



Main **Wireless Settings** My Network Firewall Parental Controls Advanced System Monitoring

Main >

Wireless Status >

Basic Security Settings >

Advanced Security Settings >

Wi-Fi Channel Analyzer >

Guest Wi-Fi Settings >

Wi-Fi Protected Setup
(WPS) >

Logout >

Guest Wi-Fi Settings

Guest Devices

Guest Wi-Fi

SSID

FiOS-AB1CD-Guest

Password

Show Password

Create without a password (Not Recommended)

Connected Guest Devices:

2

Save >

Cancel >

5. At the Warning message select the **Apply Changes & Enable Guest Wi-Fi** to proceed with Guest Wi-Fi activation.

Note: You can also toggle the Guest Wi-Fi button to ON and follow the onscreen prompts to active Guest Wi-Fi.

3.7b/ GUEST DEVICES

The devices on the Guest Wi-Fi network can be viewed on the Guest Devices page. If the admin toggles the button next to a device to OFF, that device will be blocked from accessing the Internet.

GUEST WI-FI SETTINGS



- Main >
- Wireless Status >
- Basic Security Settings >
- Advanced Security Settings >
- Wi-Fi Channel Analyzer >
- Guest Wi-Fi Settings >
- Wi-Fi Protected Setup (WPS) >
- Logout >

Guest Wi-Fi Settings

Guest Devices

Guest Wi-Fi

Guest Wi-Fi Devices List

Device	MAC Address	IP Address	Guest SSID	On/Off
 DELL-Computer	00:23:af:cd:bc:ab		FIOS-AB1CD-Guest	<input type="radio"/> OFF
 iPad	f0:84:7b:cd:ab:1a	192.168.1.2	FIOS-AB1CD-Guest	<input checked="" type="radio"/> ON

04/

CONFIGURING MY NETWORK SETTINGS

- 4.0** Accessing My Network Settings
- 4.1** Using My Network Settings

ACCESSING MY NETWORK SETTINGS

You can configure the basic network settings for your Gateway's network.

Caution: The settings described in this chapter should only be configured by experienced network technicians. Changes could adversely affect the operation of your Gateway and your local network.

4.0/ ACCESSING MY NETWORK SETTINGS

My Network allows you to view and manage your network connections and devices. You can block websites and Internet services, set port forwarding, view device details, and rename devices.

To view your network connections:

1. On the Main page, select the **My Network** icon. The My Network page opens with the current status displayed.

fios
by verizon

Main Wireless Settings **My Network** Firewall Parental Controls Advanced System Monitoring

Main >
Network Status >
Network Connections >
Logout >

My Network

Primary Network [Show More](#)

	TORAHML6R5GJX1 Device Options ▼
Connected To:	FIOS_Quantum_Gateway
Connection:	Wireless 2.4G
Connection Type:	802.11b ▲
IPv4 Address:	192.168.1.8
IP Address Allocation:	DHCP
MAC Address:	6c:8b:14:50:82:6c
Status:	Active

	ThinkPad-Edge-E440 Device Options ▼
Connected To:	FIOS_Quantum_Gateway
Connection:	Coax
IPv4 Address:	192.168.1.153
IP Address Allocation:	DHCP
MAC Address:	28:d2:44:75:c8:41
Status:	Active

Connected Devices

Ethernet:	2
Wireless 5G:	1
Wireless 2.4G:	4
Coax:	1

USING MY NETWORK SETTINGS

4.1/ USING MY NETWORK SETTINGS

To access and view common network device configuration options or device information: select My Network and locate the desired network device. Then, click on the **Device Options** drop-down menu and select the desired option as listed below. You can access and configure common network parameters:

- **Block this Device** - Click **Block this Device** to quickly enable/disable a device from having Internet access.
- **Website Blocking** - To block specific websites, click **Website Blocking**. The Parental Controls page displays.

For additional information about blocking websites, refer to **Chapter 7 Setting Parental Controls**.

- **Block Internet Services** - Internet services blocking prevents a device on your network from accessing specific services, such as receiving email or downloading files from FTP sites. Block Internet services by locating the device, then clicking **Block Internet Services**. The Access Control page displays.

For additional information on blocking Internet services, refer to the **Access Control** section in **Chapter 6 Configuring Security Settings**.

- **Port Forwarding** - Port Forwarding allows your network to be exposed to the Internet in specific limited and controlled ways. For example, you could allow specific applications, such as gaming, voice, and chat, to access servers in the local network. To access the Port Forwarding page, click **Port Forwarding**.

For additional information, refer to the **Port Forwarding** section in **Chapter 6 Configuring Security Settings**.

- **View Device Details** - Click **View Device Details** to display the Device Information page and view the selected device's information, such as IP Address, MAC address, Network Connection, Lease Type and Port Forwarding Services as well as the Ping Test option. You can also click the device's icon in the Main page to display the Device Information page.
- **Rename this Device** - To change the name of a specific device, click **Rename this Device**. The Rename Device page displays.

If desired, enter the new device name and/or select a different icon. Click **Apply** to save changes. The My Network page will open with the new name and icon displayed.

05/

USING NETWORK CONNECTIONS

- 5.0** Accessing Network Connections
- 5.1** Network (Home/Office) Connection
- 5.2** Broadband Connection
- 5.3** Wireless Access Point Connection
- 5.4** Broadband Ethernet/Coax Connection

Your Gateway supports various local area network (LAN) and wide area network (WAN), or Internet connections using Ethernet or coaxial cables.

You can configure aspects of the network and Internet connections as well as create new connections.

ACCESSING NETWORK CONNECTIONS & NETWORK (HOME/OFFICE) CONNECTION

Caution: The settings described in this chapter should only be configured by experienced network technicians. Changes could adversely affect the operation of your Gateway and your local network.

5.0/ ACCESSING NETWORK CONNECTIONS

You can access your network connections and view the connections by connection type.

To access the network connections:

1. Select **My Network**, then select **Network Connections**.

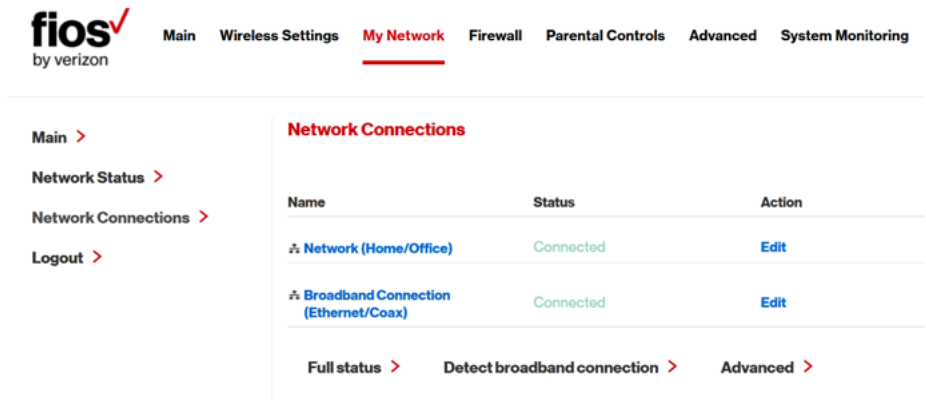

The screenshot shows the Fios network settings interface. At the top, the Fios logo is on the left, and a navigation menu includes Main, Wireless Settings, My Network (highlighted with a red underline), Firewall, Parental Controls, Advanced, and System Monitoring. On the left side, a sidebar menu lists Main >, Network Status >, Network Connections > (highlighted), and Logout >. The main content area is titled Network Connections and contains a table with the following data:

Name	Status	Action
Network (Home/Office)	Connected	Edit
Broadband Connection (Ethernet/Coax)	Connected	Edit

Below the table, there are three links: Full status >, Detect broadband connection >, and Advanced >.

2. To display all connection entries, click the **Advanced** button.



Main Wireless Settings **My Network** Firewall Parental Controls Advanced System Monitoring

Main >

Network Status >

Network Connections >

Logout >

Network Connections

NOTE: Only advanced technical users should use this feature.

Name	Status	Action
Network (Home/Office)	Connected	Edit
5.0GHz Wireless Access Point 1	Connected	Edit
2.4GHz Wireless Access Point 2	Connected	Edit
Ethernet	Connected	Edit
Coax	Cable Disconnected	Edit
Broadband Connection (Ethernet/Coax)	Connected	Edit

[Full status >](#)

[Detect broadband connection >](#)

[Basic >](#)

- To view and edit the details of a specific network connection, click the hyperlinked name or the action icon. The following sections detail the types of network connections that you can view.

5.1/ NETWORK (HOME/OFFICE) CONNECTION

You can view the properties of your local network. This connection is used to combine several network interfaces under one virtual network. For example, you can create a home/office network connection for Ethernet and other network devices.

NETWORK (HOME/OFFICE) CONNECTION

Note: When a network connection is disabled, the formerly underlying devices connected to it will not be able to obtain a new DHCP address from that Gateway network interface.

To view the connection:

1. On the Network Connections page, click the **Network (Home/Office)** connection link. The Network (Home/Office) Properties page displays.

fios
by verizon

Main Wireless Settings **My Network** Firewall Parental Controls Advanced System Monitoring

Main >
Network Status >
Network Connections >
Logout >

Network (Home/Office) Properties

Note. Only advanced technical users should use this feature.

Name:	<input type="text" value="Network (Home/Office)"/>
Status:	Connected
Network:	Network (Home/Office)
Underlying Device:	5.0GHz Wireless Access Point 1 2.4GHz Wireless Access Point 2 Ethernet Coax
Connection Type:	Bridge
MAC Address:	08:00:27:0a:00:00:00:00
IP Address:	192.168.1.1
Subnet Mask:	255.255.255.0
IP Address Distribution:	DHCP Server
Received Packets:	4070
Sent Packets:	3363
Time Span:	0:12:03

Apply > Cancel > Settings >

2. To rename a network connection, enter the new network name in the **Name** field.

3. Click **Apply** to save the changes.

CONFIGURING THE HOME/OFFICE NETWORK

To configure the network connection:

1. In the Network (Home/Office) Properties page, click **Settings**. The configuration page displays.

The screenshot shows the Fios by Verizon website interface. The navigation menu includes: Main, Wireless Settings, My Network (highlighted), Firewall, Parental Controls, Advanced, and System Monitoring. On the left, a sidebar menu shows: Main >, Network Status >, Network Connections >, and Logout >. The main content area is titled "Network (Home/Office) Properties" and includes a note: "NOTE: Only advanced technical users should use this feature." Under the "General" section, the following fields are visible: Status (Connected), Network (Network (Home/Office)), Connection Type (Bridge), Physical Address (c8a72...), MTU (Automatic, with a 1500 button), Internet Protocol (Use the Following IP Address), IP Address (192.168.1.1), and Subnet Mask (255.255.255.0).

2. Configure the following sections, as needed.

GENERAL

In the **General** section, verify the following information:

- **Status** - displays the connection status of the network.







NETWORK (HOME/ OFFICE) CONNECTION

- **Network** – displays the type of network connection.
- **Connection Type** - displays the type of connection.
- **Physical Address** - displays the physical address of the network card used for the network
- **MTU** - specifies the Maximum Transmission Unit (MTU) specifies the largest packet size permitted for Internet transmissions:
 - **Automatic** - sets the MTU at 1500
 - **Automatic by DHCP** - sets the MTU according to the DHCP connection
 - **Manual** - allows you to manually set the MTU
- **Internet Protocol** - in the internet protocol section, specify one of the following
 - **Use the Following IP Address** - the network connection uses a permanent or static IP address and subnet mask address, provided by Verizon or experienced network technician.

BRIDGE

In the **Bridge** section of the Configure Network (Home/Office), you can configure the various LAN interfaces. By default, the Ethernet, Coax, and Wireless Access Point connections are included in the 'Network (Home/Office)' bridge.

***Caution:** Do not change these settings unless specifically instructed to by Verizon. Changes could adversely affect the operation of your Gateway and your local network.*

Bridge			
Name	VLANs	Status	Action
 Network (Home/Office)	Disabled	Connected	
<input type="checkbox"/>  Broadband Connection (Ethernet/Coax)	Disabled	Connected	Edit
<input checked="" type="checkbox"/>  5.0GHz Wireless Access Point 1	Disabled	Connected	Edit
<input checked="" type="checkbox"/>  2.4GHz Wireless Access Point 2	Disabled	Connected	Edit
<input type="checkbox"/>  Ethernet	Disabled	Connected	Edit
<input checked="" type="checkbox"/>  Coax	Disabled	Cable Disconnected	Edit

Verify the following information:

- **Status** – displays the connection status of a specific network connection.
- **Action** – contains an icon that, when clicked, generates the next lower-level configuration page for the specific network connection or network device.

IP ADDRESS DISTRIBUTION

The IP Address Distribution section of the Properties settings is used to configure your Gateway's Dynamic Host Configuration Protocol (DHCP) server parameters.

NETWORK (HOME/ OFFICE) CONNECTION

IP Address Distribution:	<input type="text" value="DHCP Server"/>
Start IP Address:	<input type="text" value="192"/> . <input type="text" value="168"/> . <input type="text" value="1"/> . <input type="text" value="2"/>
End IP Address:	<input type="text" value="192"/> . <input type="text" value="168"/> . <input type="text" value="1"/> . <input type="text" value="254"/>
WINS Server:	<input type="text" value="0"/> . <input type="text" value="0"/> . <input type="text" value="0"/> . <input type="text" value="0"/>
Lease Time in Minutes:	<input type="text" value="1440"/>

Once enabled and configured, the DHCP server automatically assigns IP addresses to any network devices which are set to obtain their IP address dynamically.

If DHCP Server is enabled on your Gateway, configure the network devices as DHCP Clients. There are 2 basic options in this section: Disabled and DHCP Server.

To set up the Gateway's network bridge to function as a DHCP server:

1. In the **IP Address Distribution** section, select the DHCP server. Once enabled, the DHCP server provides automatic IP assignments (also referred to as IP leases) based on the preset IP range defined below.
 - **Start IP Address** – Enter the first IP address in the IP range that the Gateway will automatically begin assigning IP addresses from. Since your Gateway's IP address is 192.168.1.1, the default Start IP Address is 192.168.1.2.

- **End IP Address** – Enter the last IP address in the IP range that the Gateway will automatically stop the IP address allocation at. The maximum end IP address range that can be entered is 192.168.1.254.
- 2. If Windows Internet Naming Service (WINS) is being used, enter the WINS server address.
- 3. In the **Lease Time in Minutes** field, enter the amount of time a network device is allowed to connect to the Gateway with its currently issued dynamic IP address.
- 4. Click **Apply** to save changes.

ROUTING

You can configure your Gateway to use static or dynamic routing.

- **Static routing** – specifies a fixed routing path to neighboring destinations based on predetermined metrics.
- **Dynamic routing** – automatically adjusts how packets travel on the network. The path determination is based on network/device reachability and status of network being traveled.

To configure routing:

1. In the **Routing Table** section, click **Add New Route** to display and modify the new route configuration page.

NETWORK (HOME/OFFICE) CONNECTION AND BROADBAND CONNECTION



- Main >
- Network Status >
- Network Connections >
- Logout >

Route Settings

Name:

Destination:

Netmask:

Gateway:

Metric:

Apply > Cancel >

COMPLETE NETWORK CONNECTION CONFIGURATION UPDATES

To save your changes click **Apply**.

5.2/ BROADBAND CONNECTION

You can view the properties of your broadband connection (your connection to the Internet). This connection may be via either Ethernet or Coaxial cable.

To view the connection settings:

1. In the Network Connections page, click the **Broadband Connection (Ethernet/Coax)** link.

[Main](#) [Wireless Settings](#) [My Network](#) [Firewall](#) [Parental Controls](#) [Advanced](#) [System Monitoring](#)[Main >](#)[Network Status >](#)[Network Connections >](#)[Logout >](#)

Broadband Connection (Ethernet/Coax) Properties

Note: Only advanced technical users should use this feature.

[Disable >](#)

Name:	<input type="text" value="Broadband Connection (Ethernet)"/>
Status:	Connected
Network:	Broadband Connection
Connection Type:	Ethernet/Coax
MAC Address:	c8:27:5a:82:0a:91
IP Address:	71.177.238.19
Subnet Mask:	255.255.255.0
Default Gateway:	192.168.1.1
DNS Servers:	192.168.1.1 68.87.162.102
IP Address Distribution:	Disabled
IPv6 Address:	2600:fe80::5445:cafe:fe80:2600
IPv6 Link-Local Address:	fe80::5445:cafe:fe80:2600
IPv6 DNS Address 1:	2001::2001::2001
IPv6 DNS Address 2:	2001::2001::2001
Received Packets:	3374
Sent Packets:	2395
Time Span:	0:1:53
Coax Channel:	Cable Disconnected

[Apply >](#)[Cancel >](#)[Settings >](#)

2. To rename the network connection, enter the new name in the Name field.
3. Click **Apply** to save changes.

BROADBAND CONNECTION

5.2a/ CONFIGURING THE ETHERNET/COAX CONNECTION

To configure the connection:

1. In the Broadband Connection (Ethernet/Coax) Properties page, click **Settings**. The configuration page displays.

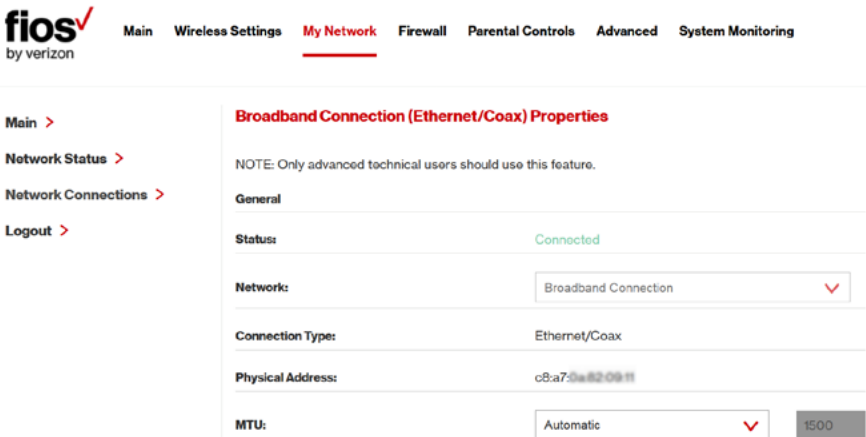

2. Configure the following settings, as needed.

GENERAL

Verify the following information:

- **Status** - displays the connection status of the network.
- **Network** – displays either your local network (Home/ Office) area connection, or your high speed broadband Internet connection.
- **Connection Type** - displays the type of connection.

- **Physical Address** - displays the physical address of the network card used for the network.
- **MTU** - specifies the largest packet size permitted for Internet transmissions:
 - **Automatic** - sets the MTU (Maximum Transmission Unit at 1500)
 - **Automatic by DHCP** - sets the MTU according to the DHCP connection
 - **Manual** - allows you to manually set the MTU.

COAX LINK

To set the Channel:

1. Navigate to the Coax Link section.

Coax Link

Privacy: Enabled

Automatically connect

Manual entry of privacy password:

Enable/Disable Coax Link: [Disable >](#)

2. Select the Automatically connect or Manual entry of privacy password, radio button in the **Auto Detection** field.

BROADBAND CONNECTION AND WIRELESS ACCESS POINT CONNECTION

3. To set privacy, select the **Enabled** check box. This causes all devices connected to the coaxial cable to use the same password. This is recommended.

Note: The password field is shown only if 'Manual entry of privacy password' is selected.

4. To set the password, enter the Coax Link password in the **Password** field.
5. To enable or disable the Coax link, click **Disable** or **Enable**.
6. To view the devices connected using the coaxial cable, click the **Go to WAN Coax Stats** link.

COMPLETE ALL ETHERNET/COAX CONNECTION CONFIGURATION UPDATES

To save your changes:

1. Click **Apply**.

5.3/ WIRELESS ACCESS POINT CONNECTION

A Wireless Access Point network connection allows wireless devices to connect to the local area network (LAN) using the 2.4 GHz or 5 GHz Wi-Fi network.

Note: Once disabled, all wireless devices connected to that wireless network will be disconnected from the LAN network and Internet.

To view the connection:

1. In the Network Connections page, click **Advanced**.



Main Wireless Settings **My Network** Firewall Parental Controls Advanced System Monitoring

Main >

Network Status >

Network Connections >

Logout >

Network Connections

NOTE: Only advanced technical users should use this feature.

Name	Status	Action
🏠 Network (Home/Office)	Connected	Edit
📶 5.0GHz Wireless Access Point 1	Connected	Edit
📶 2.4GHz Wireless Access Point 2	Connected	Edit
🏠 Ethernet	Connected	Edit
📶 Coax	Cable Disconnected	Edit
🏠 Broadband Connection (Ethernet/Coax)	Connected	Edit

[Full status >](#)

[Detect broadband connection >](#)

[Basic >](#)

2. Click 5 GHz Wireless Access Point 1 or 2.4 GHz Wireless Access Point 2.

WIRELESS ACCESS POINT CONNECTION



- Main >
- Network Status >
- Network Connections >
- Logout >

2.4GHz Wireless Access Point 2 Properties

Note: Only advanced technical users should use this feature.

Disable >

Name:	<input type="text" value="2.4GHz Wireless Access Point 2"/>
Status:	Connected
Network:	Network (Home/Office)
Connection Type:	Wireless 802.11 2.4GHz Access Point
MAC Address:	08:00:27:08:00:08:00
IP Address Distribution:	Disabled
Received Packets:	1611
Sent Packets:	2358
Time Span:	0:12:04

Apply > Cancel > Settings >

3. To disable the connection, click **Disable**.
4. To rename the connection, enter a name in the **Name** field.
5. Click **Apply** to save the changes.

5.3a/ CONFIGURING WIRELESS ACCESS POINT PROPERTIES

To configure the connection:

1. In the Wireless Access Point Properties page, click **Settings**. The configuration page displays.

The screenshot shows the Fios by Verizon website interface. The top navigation bar includes links for Main, Wireless Settings, My Network (which is underlined and highlighted in red), Firewall, Parental Controls, Advanced, and System Monitoring. On the left side, there is a sidebar menu with links for Main >, Network Status >, Network Connections >, and Logout >. The main content area is titled "2.4GHz Wireless Access Point 2 Properties" and contains a "General" section. At the top of this section is a note: "NOTE: Only advanced technical users should use this feature." Below the note are several configuration fields: "Status" is set to "Connected" in green text; "Network" is a dropdown menu currently showing "Network (Home/Office)"; "Connection Type" is set to "Wireless 802.11 2.4GHz Access Point"; "Physical Address" is labeled "c8:a7:" followed by a blurred MAC address; "MTU" is a dropdown menu set to "Automatic" with a "1500" value displayed in a grey box to its right. At the bottom of the configuration area are two buttons: a red "Apply >" button and a grey "Cancel >" button.

2. Verify the following information:
 - **Status** - displays the connection status of the network.
 - **Network** – displays the type of network connection.
 - **Connection Type** - displays the type of connection.

WIRELESS ACCESS POINT CONNECTION AND BROADBAND ETHERNET/COAX CONNECTION

- **Physical Address** - displays the physical address of the network card used for the network.
- **MTU** - specifies the largest packet size permitted for Internet transmissions:
 - **Automatic** - set the MTU (Maximum Transmission Unit) at 1500
 - **Automatic by DHCP** - sets the MTU according to the DHCP connection
 - **Manual** - allows you to manually set the MTU

3. Click **Apply** to save changes.

5.4/ BROADBAND ETHERNET/COAX CONNECTION

A Broadband Ethernet connection connects computers to your Gateway using Ethernet cables. The connections are either direct or use network hubs and switches.

A Coax connection connects devices, such as set-top boxes, to your Gateway using a coaxial cable.

Note: If disabling the connection, you must reboot your Gateway for the change to take effect.

To view the connection:

1. In the Network Connections page, click the **Broadband Connection (Ethernet/Coax)** link.

The screenshot shows the Fios by Verizon network management interface. The navigation menu includes Main, Wireless Settings, My Network (highlighted), Firewall, Parental Controls, Advanced, and System Monitoring. The left sidebar shows a breadcrumb trail: Main > Network Status > Network Connections > Logout >. The main content area is titled "Broadband Connection (Ethernet/Coax) Properties" and includes a note: "Note: Only advanced technical users should use this feature." A red "Disable >" button is visible. Below is a table of network properties:

Name:	Broadband Connection (Ethernet/Coax)
Status:	Connected
Network:	Broadband Connection
Connection Type:	Ethernet/Coax
MAC Address:	c8:a7:3a:82:06:91
IP Address:	71.87.236.86
Subnet Mask:	255.255.255.0
Default Gateway:	192.168.1.1
DNS Servers:	192.168.1.1 68.253.64.10

2. To rename the network connection, enter the new name in the **Name** field.
3. Click **Apply** to save changes.

5.4a/ CONFIGURING THE ETHERNET/COAX CONNECTION

To configure the connection:

1. In the Broadband Connection (Ethernet/Coax) Properties page, click **Settings**. The configuration page displays.

BROADBAND ETHERNET/ COAX CONNECTION

The screenshot shows the Fios network management interface. The top navigation bar includes 'Main', 'Wireless Settings', 'My Network' (underlined), 'Firewall', 'Parental Controls', 'Advanced', and 'System Monitoring'. The left sidebar has 'Main >', 'Network Status >', 'Network Connections >', and 'Logout >'. The main content area is titled 'Broadband Connection (Ethernet/Coax) Properties' and contains a note: 'NOTE: Only advanced technical users should use this feature.' Below the note is a 'General' section with the following fields: 'Status' (Connected), 'Networks' (Broadband Connection), 'Connection Type' (Ethernet/Coax), 'Physical Address' (c8:a7:45:83:00:00), 'MTU' (Automatic), and 'Coax Link'.

2. Configure the following settings, as needed.

GENERAL

Verify the following information:

- **Status** - displays the connection status of the network
- **Network** – displays the type of network connection
- **Connection Type** - displays the type of connection
- **Physical Address** - displays the physical address of the network card used for the network
- **MTU** - specifies the largest packet size permitted for Internet transmissions:
 - **Automatic** - set the MTU (Maximum Transmission Unit) at 1500

- **Automatic by DHCP** - sets the MTU according to the DHCP connection
- **Manual** - allows you to manually set the MTU

COAX LINK

1. Navigate to the Coax Link section.

Coax Link

Privacy: Enabled

Automatically connect
 Manual entry of privacy password:

Enable/Disable Coax Link: [Disable >](#)

Coax Connection Stats: [Go to WAN Coax Stats](#)

WAN Coax Connection Speeds

2. Select the Automatically connect or Manual entry of privacy password, radio button in the Auto Detection field.
3. To set privacy, select the **Enabled** check box. This causes all devices connected to the coaxial cable to use the same password. This is recommended.
4. To set the password, enter the Coax Link password in the **Password** field.
5. To enable or disable the Coax link, click **Disable** or **Enable**.

BROADBAND ETHERNET/ COAX CONNECTION

6. To view the devices connected using the coaxial cable, click the **Go to WAN Coax Stats** link.

INTERNET PROTOCOL

1. In the Internet Protocol section, specify one of the following:
 - **No IP Address** – the connection has no IP address. This is useful if the connection operates under a bridge.
 - **Obtain an IP Address Automatically** – the network connection is required by Verizon to obtain an IP address automatically. The server assigning the IP address also assigns a subnet mask address, which can be overridden by entering another subnet mask address.
 - **Use the Following IP Address** - the network connection uses a permanent or static IP address, then the IP address and subnet mask address.

Router Tx (Mbps):	0.00
Router Rx (Mbps):	0.00
Internet Protocol:	Obtain IP Address Automatically ▼
<input type="checkbox"/> Override Subnet Mask:	<input type="text" value="0"/> . <input type="text" value="0"/> . <input type="text" value="0"/> . <input type="text" value="0"/>
DHCP Lease:	Release > Renew >

2. To override the subnet mask, select the **Override Subnet Mask** check box, then enter the new subnet mask.

COMPLETE ALL ETHERNET/COAX CONNECTION CONFIGURATION UPDATES

To save your changes:

1. Click Apply.

06/

CONFIGURING SECURITY SETTINGS

- 6.0** Firewall
 - 6.1** Access Control
 - 6.2** Port Forwarding
 - 6.3** Port Triggering
 - 6.4** DMZ Host
 - 6.5** Remote Administration
 - 6.6** Static NAT
 - 6.7** Security Log

Your Gateway's security suite includes comprehensive and robust security services, such as stateful packet inspection, firewall security, user authentication protocols, and password protection mechanisms.

These and other features help protect your computers from security threats on the Internet.

FIREWALL

This chapter covers the following security features:

- **Firewall** - select the security level for the firewall.
- **Access Control** - restrict access from the local network to the Internet.
- **Port Forwarding** - enable access from the Internet to specified services provided by computers on the local network.
- **Port Triggering** - define port triggering entries to dynamically open the firewall for some protocols or ports.
- **DMZ Host** - allows a single device on your primary network to be fully exposed to the Internet for special purposes such as Internet Gaming.
- **Remote Administration** - enable remote configuration of your gateway from any Internet-accessible computer.
- **Static NAT** - allow multiple static NAT IP addresses to be designated to devices on the network.
- **Security Log** - view and configure the security log.

6.0/ FIREWALL

The firewall is the cornerstone of the security suite for your Gateway. It has been exclusively tailored to the needs of the residential or office user and is pre-configured to provide optimum security.

The firewall provides both the security and flexibility home and office users seek. It provides a managed, professional level of network security while enabling the safe use of interactive applications, such as Internet gaming and video conferencing.

Additional features, including surfing restrictions and access control, can also be configured locally through the user interface or remotely by a service provider.

The firewall regulates the flow of data between the local network and the Internet. Both incoming and outgoing data are inspected, then either accepted and allowed to pass through your Gateway or rejected and barred from passing through your Gateway, according to a flexible and configurable set of rules. These rules are designed to prevent unwanted intrusions from the outside, while allowing local network users access to Internet services.

The firewall rules specify the type of services on the Internet that are accessible from the local network and types of services in the local network that are accessible from the Internet.

Each request for a service that the firewall receives is checked against the firewall rules to determine whether the request should be allowed to pass through the firewall. If the request is permitted to pass, all subsequent data associated with this request or session is also allowed to pass, regardless of its direction.

For example, when accessing a website on the Internet, a request is sent to the Internet for this site. When the request reaches your Gateway, the firewall identifies the request type and origin, such as HTTP and a specific computer in the local network. Unless your Gateway is configured to block requests of this type from this computer, the firewall allows this type of request to pass to the Internet.

When the website is returned from the web server, the firewall associates the website with this session and allows it to pass;

FIREWALL

regardless of whether HTTP access from the Internet to the local network is blocked or permitted.

It is the origin of the request, not subsequent responses to this request, which determines whether a session can be established.

6.0a/ SETTING FIREWALL CONFIGURATION

You can select a maximum, typical, or minimum security level to block, limit, or permit all traffic. The following table shows request access for each security level.

Security Level	Internet Requests <i>Incoming Traffic</i>	Local Network Requests <i>Outgoing Traffic</i>
Maximum	Blocked	Limited
Typical	Blocked	Unrestricted
Minimum	Unrestricted	Unrestricted

The request access is defined as:

- **Blocked traffic** - no access allowed, except as configured in Port Forwarding and Remote Access
- **Limited** - permits only commonly used services, such as email and web browsing
- **Unrestricted** - permits full access of incoming traffic from the Internet and allows all outgoing traffic, except as configured in Access Control

6.0b/ SPECIFYING GENERAL SETTINGS FOR IPV4 OR IPV6

To set your firewall configuration:

1. From the Firewall General settings page click on desired IPv4 or IPv6 option to configure the desired IPv4 or IPv6 security settings:

fios
by verizon

Main Wireless Settings My Network **Firewall** Parental Controls Advanced System Monitoring

Main >
General >
Access Control >
Port Forwarding >
Port Triggering >
DMZ Host >
Remote Administration >
Static NAT >
Security Log >
Logout >

General

IPv4 Settings

Maximum Security (High)
Inbound Policy: **Reject.**
Remote Administration settings will override the security inbound policy.
Outbound Policy: **Reject.**
Outbound access is allowed to the following services: DHCP, DNS, IMAP, SMTP, POP3, HTTPS, HTTP, FTP, Telnet.
 Allow outbound Set Top Box traffic

Typical Security (Medium)
Inbound Policy: **Reject.**
Remote Administration settings will override the security inbound policy.
Outbound Policy: **Accept.**

Minimum Security (Low)
Inbound Policy: **Accept.**
Outbound Policy: **Accept.**

IPv6 Settings

Maximum Security (High)
Inbound Policy: **Reject.**
Outbound Policy: **Reject.**
Outbound access is allowed to the following services: DHCP, DNS, IMAP, SMTP, POP3, HTTPS, HTTP, Telnet.

Typical Security (Medium)
Inbound Policy: **Reject.**
Outbound Policy: **Accept.**

Minimum Security (Low)
Inbound Policy: **Accept.**
Outbound Policy: **Accept.**

FIREWALL AND ACCESS CONTROL

2. Select a security level by clicking one of the radio buttons. Using the Minimum Security setting may expose the local network to significant security risks, and should only be used for short periods of time to allow temporary network access.
3. Click **Apply** to save changes.

Note: If Maximum Security (High) option is selected you may also need to check the box 'Allow outbound Set Top Box traffic' to allow for Set Top Box traffic (e.g. program information, etc.) to pass through the router's firewall.

6.1/ ACCESS CONTROL

You can block individual computers on your local network from accessing specific services on the Internet. For example, you could block one computer from accessing the Internet, then block a second computer from transferring files using FTP as well as prohibit the computer from receiving incoming email.

Access control incorporates a list of preset services, such as applications and common port settings.

6.1a/ ALLOW OR RESTRICT SERVICES

To allow or restrict services:

1. From the Firewall page, select **Access Control**. The Access Control page opens with the Allowed and Blocked sections displayed. The Allowed section only displays when the firewall is set to maximum security.

Main >
General >
Access Control >
Port Forwarding >
Port Triggering >
DMZ Host >
Remote Administration >
Static NAT >
Security Log >
Logout >

Access Control

Block access to the Internet services from within the LAN.

Networked Computer/Device	Network Address	Protocols	Status	Action
Add +				

Apply > **Cancel >**

2. To block a service, click **Add**. The Add Access Control Rule page displays.

Main >
General >
Access Control >
Port Forwarding >
Port Triggering >
DMZ Host >
Remote Administration >
Static NAT >
Security Log >
Logout >

Add Access Control Rule

Networked Computer / Device

Protocol

When should this rule occur?

Apply > **Cancel >**

ACCESS CONTROL AND PORT FORWARDING

3. To apply the rule to:
 - **All networked devices** - select **Any**.
 - **Specific devices only** - select **User Defined**, then click **Add** and create a network object.
4. In the **Protocol** field, select the Internet protocol to be allowed or blocked.

If the service is not included in the list, select **User Defined**. The Edit Service page displays. Define the service, then click **OK**. The service is automatically added to the **Add Access Control Rule** section.
5. Specify when the rule is active as **Always** or **User Defined** and click **Add** to create the schedule.
6. Click **Apply** to save changes. The Access Control page displays a summary of the new access control rule.

6.1b/ DISABLE ACCESS CONTROL

You can disable an access control and enable access to the service without removing the service from the Access Control table. This can make the service available temporarily and allow you to easily reinstate the restriction later.

- To disable an access control, clear the check box next to the service name.
- To reinstate the restriction, select the check box next to the service name.
- To remove an access restriction, select the service and click **Remove**. The service is removed from the Access Control table.

6.2/ PORT FORWARDING

You can activate port forwarding to expose the network to the Internet in a limited and controlled manner. For example, enabling applications, such as gaming and voice, to work from the local network as well as allowing Internet access to servers within the local network.

To create port forwarding rules:

1. From the Firewall page, select **Port Forwarding**. The Port Forwarding page opens with the current rules displayed.

The screenshot shows the Verizon Fios web interface for configuring port forwarding. The top navigation bar includes the Fios logo and menu items: Main, Wireless Settings, My Network, Firewall (highlighted), Parental Controls, Advanced, and System Monitoring. On the left, a sidebar menu lists various settings categories, with 'Port Forwarding' selected. The main content area is titled 'Port Forwarding' and contains a description: 'This feature enables applications (Games, Webcams, IM & Others) by opening a tunnel between remote (Internet) computers and a specific device port inside your local area network(LAN)'. Below the description is a section for creating a new rule with two dropdown menus: 'Select IP from menu' and 'Application To Forward...'. Underneath are buttons for 'Add +', 'Reset >', 'Cancel >', and 'Advanced >>'. A table titled 'Applied rules:' shows one active rule. The table has columns for 'Networked Computer / Device', 'Applications & Ports Forwarded', 'Status', and 'Delete'. The rule listed is for 'localhost 127.0.0.1' forwarding 'Verizon Fios Service TCP Any -> 4567' with a status of 'Active'. At the bottom of the table are 'Apply >' and 'Delete >' buttons.

fios
by verizon

Main Wireless Settings My Network **Firewall** Parental Controls Advanced System Monitoring

Main >
General >
Access Control >
Port Forwarding >
Port Triggering >
DMZ Host >
Remote Administration >
Static NAT >
Security Log >
Logout >

Port Forwarding

This feature enables applications (Games, Webcams, IM & Others) by opening a tunnel between remote (Internet) computers and a specific device port inside your local area network(LAN).

Create new port forwarding rule:

Select IP from menu Application To Forward...

Add + Reset > Cancel > Advanced >>

Applied rules:

Networked Computer / Device	Applications & Ports Forwarded	Status	Delete
localhost 127.0.0.1	Verizon Fios Service TCP Any -> 4567	Active	

Apply > Delete >

PORT FORWARDING AND PORT TRIGGERING

2. To create a new rule, select the IP address in the **Select IP from Menu** drop down.
3. Select the application in the **Application to Forward** drop down.
4. Click **Add**. The rule displays in the **Applied Rules** section.
5. Click **Apply** to save changes.
6. To delete a created Rule, simply check box under the **Delete** column and click the Delete option

6.2a/ ADVANCED PORT FORWARDING RULES

You can configure advanced port forwarding rules.

To configure the rules:

1. In the Port Forwarding page, select **Advanced**.

The screenshot shows the Fios by Verizon Firewall configuration page. The navigation menu includes Main, Wireless Settings, My Network, Firewall (highlighted), Parental Controls, Advanced, and System Monitoring. The left sidebar lists various settings categories: Main, General, Access Control, Port Forwarding, Port Triggering, DMZ Host, Remote Administration, Static NAT, Security Log, and Logout. The main content area is titled "Port Forwarding" and includes a description: "This feature enables applications (Games, Webcams, IM & Others) by opening a tunnel between remote (Internet) computers and a specific device port inside your local area network(LAN)." Below this is a "Create new port forwarding rule:" section with two dropdown menus: "192.168.1.10 - HP-Printer" and "Custom Ports". The "Advanced Settings" section contains a table with three columns: Protocol, Source Ports, and Destination Ports. The Protocol is set to TCP, Source Ports to Any, and Destination Ports to Any. Below the table are "Forward to Port" and "Schedule" sections. "Forward to Port" is set to "Same as Incoming Port" and "Schedule" is set to "Always". At the bottom, there are buttons for "Add +", "Reset", "Cancel", and "Basic <<".

fios by verizon

Main Wireless Settings My Network **Firewall** Parental Controls Advanced System Monitoring

Main >
General >
Access Control >
Port Forwarding >
Port Triggering >
DMZ Host >
Remote Administration >
Static NAT >
Security Log >
Logout >

Port Forwarding

This feature enables applications (Games, Webcams, IM & Others) by opening a tunnel between remote (Internet) computers and a specific device port inside your local area network(LAN).

Create new port forwarding rule:

192.168.1.10 - HP-Printer Custom Ports

Advanced Settings

Protocol	Source Ports	Destination Ports
TCP	Any	Any

Forward to Port: Same as Incoming Port

Schedule: Always

Add + Reset > Cancel > Basic <<

2. If needed, to select a port to forward communication to, select an option in the **Forward to Port** list box.
3. If a single port or range of ports is selected, a text box displays. Enter the port numbers.
4. To schedule the rule, select either **Always** or **User Defined** in the **Schedule** list box.
5. Click **Add**. The rule displays in the **Applied Rules** section.
6. Click **Apply** to save changes.
7. To delete a created Rule, simply check box under the **Delete** column and click the Delete option

6.3/ PORT TRIGGERING

Port triggering can be described as dynamic port forwarding. By setting port triggering rules, inbound traffic arrives at a specific network host using ports that are different than those used for outbound traffic. The outbound traffic triggers the ports where the inbound traffic is directed.

For example, a gaming server is accessed using UDP protocol on port 2222. The gaming server then responds by connecting the user using UDP on port 3333, when a gaming session is initiated.

In this case, port triggering must be used since it conflicts with the following default firewall settings:

- Firewall blocks inbound traffic by default.

PORT TRIGGERING AND DMZ HOST

- Server replies to your Gateway IP, and the connection is not sent back to the host since it is not part of a session.

To resolve the conflict, a port triggering entry must be defined, which allows inbound traffic on UDP port 3333 only after a network host generated traffic to UDP port 2222. This results in your Gateway accepting the inbound traffic from the gaming server and sending it back to the network host which originated the outgoing traffic to UDP port 2222.

To configure port triggering:

1. Select **Port Triggering**.

The screenshot shows the Fios router's web interface. The top navigation bar includes: Main, Wireless Settings, My Network, **Firewall** (highlighted with a red underline), Parental Controls, Advanced, and System Monitoring. On the left, a sidebar menu lists: Main >, General >, Access Control >, Port Forwarding >, Port Triggering > (highlighted), DMZ Host >, Remote Administration >, Static NAT >, Security Log >, and Logout >. The main content area is titled "Port Triggering" and contains the following text: "Trigger opening of ports for incoming data." and "NOTE: Only advanced technical users should use this feature." Below this is a table with columns: Protocol, Outgoing Trigger Ports, Incoming Ports to Open, and Action. Two entries are listed: 1. L2TP Triggering - Layer Two Tunneling Protocol (checked), Outgoing Trigger Ports: UDP Any -> 1701, Incoming Ports to Open: UDP Any -> Same as Initiating Ports, Action: Edit Remove. 2. TFTP Triggering - Trivial File Transfer Protocol (checked), Outgoing Trigger Ports: UDP 1024 - 65535 -> 69, Incoming Ports to Open: UDP Any -> Same as Initiating Ports, Action: Edit Remove. At the bottom of the table is a red "Add +" button. Below the table are two buttons: "Apply >" and "Cancel >".

Protocol	Outgoing Trigger Ports	Incoming Ports to Open	Action
<input checked="" type="checkbox"/> L2TP Triggering - Layer Two Tunneling Protocol	UDP Any -> 1701	UDP Any -> Same as Initiating Ports	Edit Remove
<input checked="" type="checkbox"/> TFTP Triggering - Trivial File Transfer Protocol	UDP 1024 - 65535 -> 69	UDP Any -> Same as Initiating Ports	Edit Remove

2. To add a service as an active protocol, click **Add**. The Edit Port Triggering Rule page displays.

[Main](#) [Wireless Settings](#) [My Network](#) [Firewall](#) [Parental Controls](#) [Advanced](#) [System Monitoring](#)[Main >](#)
[General >](#)
[Access Control >](#)
[Port Forwarding >](#)
[Port Triggering >](#)
[DMZ Host >](#)
[Remote Administration >](#)
[Static NAT >](#)
[Security Log >](#)
[Logout >](#)

Edit Port Triggering Rule

Service Name:

Outgoing Trigger Ports

Protocol	Server Ports	Action
----------	--------------	--------

[New trigger ports >](#)

Incoming Ports to Open

Protocol	Opened Ports	Action
----------	--------------	--------

[New opened ports >](#)

[Apply >](#) [Cancel >](#)

3. Enter the service name then configure its inbound and outbound trigger ports. Click **Apply** to save User Defined changes. The Port Triggering page displays.
4. Click **Apply** again to save all changes.
5. To delete a created Rule, simply check box under the **Delete** column and click the Delete option

DMZ HOST AND REMOTE ADMINISTRATION

6.4/ DMZ HOST

DMZ Host allows a single device on your primary network to be fully exposed to the Internet for special purposes like Internet gaming.

Warning: Enabling DMZ Host is a security risk. When a device on your network is a DMZ Host, it is directly exposed to the Internet and loses much of the protection of the firewall. If it is compromised, it can also be used to attack other devices on your primary network.

Follow these steps to designate a device on your primary network as a DMZ Host:

1. From the Firewall page, select DMZ Host
2. Select Enable for the DMZ Host
3. Enter the IP address of the device you want to designate as the DMZ Host
4. Click Apply



Main Wireless Settings My Network **Firewall** Parental Controls Advanced System Monitoring

- Main >
- General >
- Access Control >
- Port Forwarding >
- Port Triggering >
- DMZ Host >
- Remote Administration >
- Static NAT >
- Security Log >
- Logout >

DMZ Host Settings

Allow a single networked computer /device to be fully exposed to the Internet.

Note: If you have purchased a group of Static IP's and have enabled Static NAT for all your Static IPs, do NOT enable the DMZ Host feature.

DMZ Host: Disable Enable

IP Address: 192 . 168 . 1 .

Apply > Cancel >

6.5/ REMOTE ADMINISTRATION

Caution: Enabling Remote Administration places your Gateway network at risk from outside attacks.

You can access and control your Gateway not only from within the local network, but also from the Internet using Remote Administration.

You can allow incoming access to the following:

- **Web Management** - used to obtain access to your Gateway's GUI and gain access to all settings and parameters through a web browser.
- **Diagnostic Tools** - used for troubleshooting and remote system management by a user or Verizon.

Web Management remote administration access may be used to modify or disable firewall settings. Local IP addresses and other settings can also be changed, making it difficult or impossible to access your Gateway from the local network. Remote administration access to SSH or Web Management services should be activated only when absolutely necessary.

Note: Encrypted remote administration is performed using a secure SSL connection and requires a SSL certificate. When accessing your Gateway for the first time using encrypted remote administration, a warning page opens with a certificate authentication message displayed. This is due to your Gateway SSL certificate being self-generated. When this message displays, ignore the message and continue. Even though this message displays, the self-generated certificate is safe and provides a secure SSL connection.

REMOTE ADMINISTRATION AND STATIC NAT

To enable remote administration:

1. Select Remote Administration.

The screenshot shows the Fios router's web interface. At the top left is the 'fios by verizon' logo. A navigation bar contains the following items: 'Main', 'Wireless Settings', 'My Network', 'Firewall' (which is underlined in red), 'Parental Controls', 'Advanced', and 'System Monitoring'. On the left side, there is a sidebar menu with the following items: 'Main >', 'General >', 'Access Control >', 'Port Forwarding >', 'Port Triggering >', 'DMZ Host >', 'Remote Administration >' (highlighted in red), 'Static NAT >', 'Security Log >', and 'Logout >'. The main content area is titled 'Remote Administration' in red. Below the title, there is a warning: 'Configure Remote Administration to the router. Attention: With Remote Administration enabled, your network will be at risk from outside attacks.' Underneath this is a section titled 'Allow Incoming WAN Access to Web-Management' with two checkboxes: 'Using Primary HTTPS Port (443)' and 'Using Secondary HTTPS Port (8443)'. Below that is a section titled 'Diagnostic Tools' with two checked checkboxes: 'Allow Incoming WAN ICMP Echo Requests (e.g. pings and ICMP traceroute queries)' and 'Allow Incoming WAN UDP Traceroute Queries'. At the bottom of the page, there are two buttons: a red 'Apply >' button and a 'Cancel >' button.

2. To enable access, select the check box.
3. Click **Apply** to save changes.
4. To remove access, clear the check box.
5. Click **Apply** again to save changes.

6.6/ STATIC NAT

Static NAT allows devices located behind a firewall that is configured with private IP addresses to appear to have public IP addresses to the Internet. This allows an internal host, such as a web server, to have an unregistered (private) IP address and still be accessible over the Internet.

To configure static NAT:

1. Select **Static NAT**.

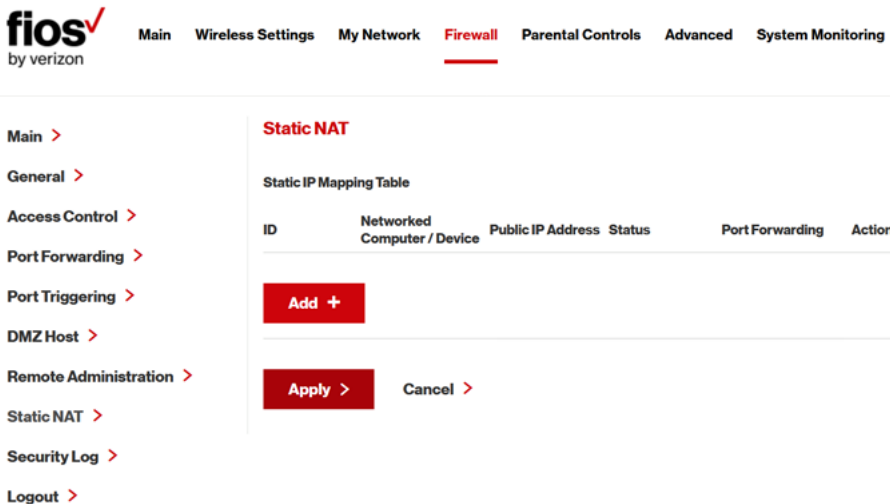

The screenshot shows the Fios by Verizon router configuration interface. The top navigation bar includes: Main, Wireless Settings, My Network, **Firewall** (highlighted with a red underline), Parental Controls, Advanced, and System Monitoring. On the left, a sidebar menu lists: Main >, General >, Access Control >, Port Forwarding >, Port Triggering >, DMZ Host >, Remote Administration >, **Static NAT >**, Security Log >, and Logout >. The main content area is titled "Static NAT" and contains a "Static IP Mapping Table". The table has columns for ID, Networked Computer / Device, Public IP Address, Status, Port Forwarding, and Action. Below the table is a red "Add +" button. At the bottom of the configuration area are "Apply >" and "Cancel >" buttons.

2. To create a static NAT, click **Add**. The Add NAT/NAPT Rule page displays.

STATIC NAT AND SECURITY LOG

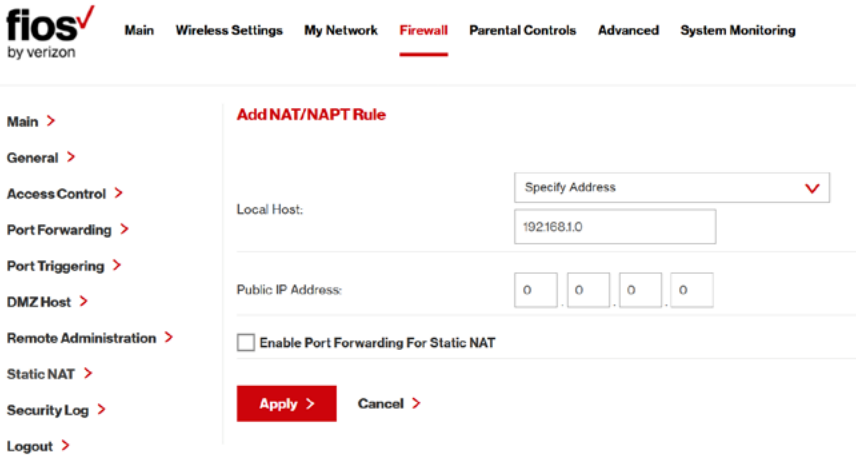

3. Select a source address in the **Specify Address** field or enter an IP address in the text box.
4. Enter the public IP address.
5. If using port forwarding, select the **Enable Port Forwarding for Static NAT** check box.
6. Click **Apply** to save changes.
7. Repeat these steps to add additional static IP addresses.

6.7/ SECURITY LOG

You can view events that your firewall has blocked by accessing the security log. Your Gateway reports events, such as attempts to establish inbound and outbound connections, attempts to authenticate at an administrative interface, such as your Gateway GUI, firewall configuration, and system start-up.

The security log reports the following information:

- **Time** - based on the date and time in your Gateway
- **Event Type** - consists of firewall information, firewall setup, and system log
- **Log Level** - describes the event that occurred, such as a fragmented packet or parental controls.
- **Details** - provide a reason the event occurred, such as a packet has been blocked because of parental controls.

You can modify the type of events that display in the security log. This does not modify the event itself. It simply changes the information that displays in the log.

6.7a/ EVENT TYPES

The security log records the following event types:

- **Access control** – a packet has been accepted/blocked due to an access control rule.
- **Advance filter rule** – a packet has been accepted/blocked due to an advanced filter rule.
- **ARP** – an ARP packet has been accepted.
- **AUTH:113 request** - an outbound packet for AUTH protocol has been accepted (for maximum security level).
- **Broadcast/Multicast protection** – a packet with a broadcast/multicast source IP has been blocked.

SECURITY LOG

- **Default policy** – a packet has been accepted/blocked according to the default policy.
- **Defragmentation failed** – the fragment has been stored in memory and blocked until all fragments have arrived and defragmentation can be performed.
- **DHCP request** – your Gateway sent a DHCP request (depends on the distribution).
- **DHCP response** - your Gateway sent a DHCP response (depends on the distribution).
- **Echo/Chargen/Quote/Snork protection** – a packet has been blocked due to Echo/Chargen/Quote/Snork protection.
- **Firewall internal** – from the firewall internal mechanism, event type is recorded and an accompanying explanation will be added.
- **Firewall rules were changed** – the rule set has been modified.
- **Firewall status changed** – the firewall status changed from up to down or vice versa, as specified in the event type description.
- **First packet in connection is not a SYN packet** – a packet has been blocked due to a TCP connection that started without a SYN packet.
- **Fragmented packet** – a fragment has been rejected.
- **Fragmented packet, bad align** – a packet has been blocked because, after defragmentation, the packet was badly aligned.
- **Fragmented packet, header too big** – a packet has been blocked because, after defragmentation, the header was too big.

-
- **Fragmented packet, header too small** – a packet has been blocked because, after defragmentation, the header was too small.
 - **Fragmented packet, no memory** – a packet has been blocked because there is no memory for fragments.
 - **Fragmented packet, overlapped** – a packet has been blocked because, after defragmentation, there were overlapping fragments.
 - **Fragmented packet, packet exceeds** – a packet has been blocked because, after defragmentation, the packet exceeded.
 - **Fragmented packet, packet too big** – a packet has been blocked because, after defragmentation, the packet was too big.
 - **FTP port request to 3rd party is forbidden** – possible bounce attack – a packet has been blocked.
 - **ICMP flood protection** – a broadcast ICMP (Internet Control Message Protocol) flood.
 - **ICMP protection** – a broadcast ICMP message has been blocked.
 - **ICMP redirect protection** – an ICMP redirected message has been blocked.
 - **ICMP replay** – an ICMP replay message has been blocked.
 - **Illegal packet options** – the options field in the packet's header is either illegal or forbidden.

SECURITY LOG

- **IP Version 6** – an IPv6 packet has been accepted.
- **Malformed packet: Failed parsing** – a packet has been blocked because it is malformed.
- **Maximum security enabled service** – a packet has been accepted because it belongs to a permitted service in the maximum security level.
- **Multicast IGMP connection** – a multicast packet has been accepted.
- **NAT Error: Connection pool is full - No connection created** – a connection has not been created because the connection pool is full.
- **NAT Error: Conflict mapping already exists** – a conflict occurred because the NAT mapping already exists, so NAT failed.
- **NAT Error: No free NAT IP** – no free NAT IP, so NAT has failed.
- **NAT out failed** – NAT failed for this packet.
- **Outbound Auth1X** – an outbound Auth1X packet has been accepted.
- **Packet invalid in connection** – an invalid connection packet has been blocked.
- **Parental controls** – a package has been blocked because of parental controls.
- **Passive attack on ftp-server: Client attempted to open Server ports** – a packet has been blocked.

- **Service** – a packet has been accepted because of a certain service, as specified in the event type.
- **Spoofing protection** – a packet from the Internet with a source IP belong to the local network has been blocked.
- **STP packet** – STP (Spanning Tree Protocol) packet has been accepted/rejected.
- **SynCookies protection** – a SynCookies packet has been blocked.
- **Trusted device** – a packet from a trusted device has been accepted.
- **UDP flood protection** – a packed has been blocked, stopping a UDP flood.
- **User authentication** – a message arrived during login time, including both successful and failed authentication.
- **Wildcard connection hooked** – debug message regarding connection.
- **Wildcard connection opened** - debug message regarding connection.
- **WinNuke protection** – a WinNuke attack has been blocked.

To view or edit the security log:

Select **Security Log**.

SECURITY LOG

The screenshot shows the Fios Security Log page. The navigation bar includes: Main, Wireless Settings, My Network, Firewall (highlighted), Parental Controls, Advanced, and System Monitoring. The left sidebar contains: Main >, General >, Access Control >, Port Forwarding >, Port Triggering >, DMZ Host >, Remote Administration >, Static NAT >, Security Log >, and Logout >. The main content area is titled "Security Log" and includes buttons for Close >, Clear log >, Save log >, Hazard >, Settings >, and Refresh >. Below these buttons is the instruction: "Press the Refresh button to update the data." A table displays log entries with columns: Time, Event-Type, Log Level, and Details.

Time	Event-Type	Log Level	Details
Jul 20 21:54:03 2017	System	warn<164>	Failed login to web UI from 192.168.12.59895
Jul 20 21:54:03 2017	System	info<166>	Successful login to web UI

To modify the types of events that display in the log, click **Settings**.

The screenshot shows the Fios Log Settings page. The navigation bar is identical to the previous screenshot. The left sidebar is also identical. The main content area is titled "Log Settings" and is divided into "Accepted Events" and "Blocked Events" sections.

Accepted Events

- Accepted Incoming Connections
- Accepted Outgoing Connections

Blocked Events

- All Blocked Connection Attempts
- Winnuke
- Multicast/Broadcast
- ICMP Replay
- Defragmentation Error
- Spoofed Connection
- ICMP Redirect
- Blocked Fragments
- Packet Illegal Options
- ICMP Multicast
- Syn Flood
- UDP Flood
- ICMP Flood

In the **Accepted Events** section, select the type of activities that generates a log message:

- **Accepted Incoming Connections** – generates a log message for each successful attempt to establish an inbound connection to the local network.
- **Accepted Outgoing Connections** - generates a log message for each successful attempt to establish an outbound connection to the public network.

In the **Blocked Events** section, select the type of blocked events you want logged.

To log a message for each remote administration connection attempt, click the **Remote Administration Attempts** check box.

To log the connection for handling by the firewall and application level Gateways, click the **Connection States** check box.

Click **Apply** to save changes. The Security Log page displays.

To view the **Security Hazard Log** details, click on the Hazard option on the Security Log page and a log of the current alerts/hazard events will be displayed.

To Save the existing log details, click on the **Save log** option on the Security Log page and the current security log will be saved to your web browser's download folder

To clear and reset the existing log details, click on the **Clear log** option on the Security Log page.

07/

SETTING PARENTAL CONTROLS

- 7.0** Activating Parental Controls
- 7.1** Rule Summary
- 7.2** Activating Advanced Parental Controls

The abundance of harmful information on the Internet poses a serious challenge for employers and parents alike as they ask “How can I regulate what my employee or child does on the Internet?” With that question in mind, your Gateway’s Parental Controls were designed to allow control of Internet access on all locally networked devices.

Verizon is also now offering an advanced parental controls solution that offers more robust security features to protect your devices in your home or business.

ACTIVATING PARENTAL CONTROLS

7.0/ ACTIVATING PARENTAL CONTROLS

You can create a basic access policy for any computer or device on your Gateway network. Parental controls limit Internet access to specific websites based on a schedule that you create.

Access can be limited on specific websites or keywords embedded in a website. For example, you can block access to the 'www.anysite.com' as well as block any website that has the word 'any' in its site name.

Use the 'Click here' link on the Parental Controls page to learn more about the new advanced parental controls and to get started using it with the My Fios app.

To limit computer access:

1. Select **Parental Controls**.

The screenshot shows the Verizon Fios web interface for configuring Parental Controls. The navigation bar includes: Main, Wireless Settings, My Network, Firewall, Parental Controls (highlighted), Advanced, and System Monitoring. The left sidebar has links for Main, Parental Controls, Rule Summary, and Logout. The main content area is titled 'Parental Controls' and contains the following text: 'The Router enables a user to set up Parental Controls made up of a list of website addresses and/or keywords embedded in website addresses that will limit the computer user's internet access. Simply follow the 3 Steps below and click the Apply button to set up your Parental Controls.' Below this is a 'New!' announcement: 'Verizon is now offering an advanced parental control solution that offers more robust security features to protect your devices in your home or business. Click here to learn more and get started using it today on the My Fios app.' A section for 'Verizon My Fios' includes the text 'The My Fios App is compatible with iPad®, iPhone®, and Android™' and buttons for 'Download on the App Store' and 'GET IT ON Google play'. A 'Step 1' instruction reads: 'Select the Primary/Guest Network Device for this Allow or Block Rule.' Below this is a 'What's this?' link. The configuration area is split into 'Primary Network & Guest Network Device List:' and 'Selected Devices:'. The 'List:' section contains a scrollable list of devices: HP-Printer, asus-pc, iPhone, TORAHML6R5GJX1, htcPhone, and ThinkPad-Edge-E440. There are 'Add >>' and '<< Remove' buttons between the two sections.

2. In **Step 1** (optional), select the computers or device where you are limiting access in the **Primary Network & Guest Network Device List**, then click **Add**. The devices display in the **Selected Devices** section.
3. To remove a device from the **Selected Devices** list box, select the device, then click **Remove**. The device displays in the **Primary Network & Guest Network Device List**.
4. In **Step 2**, click one of the following options in the **Limit Access By** section:
 - **Block the following Websites and Embedded Keywords within a URL** – blocks the specified websites and websites with names contained the specified keyword.
 - **Allow the following Websites and Embedded Keywords within a URL** – allows the specified websites and websites with names contained the specified keyword.
 - **Block ALL Internet Access** – will not allow the device to access the Internet.
5. Enter the name of the website or keyword, then click **Add**.

ACTIVATING PARENTAL CONTROLS AND RULE SUMMARY

Step 2 Create the Parental Control Rules and Schedules.

Limit Access By: [What's this?](#)

Block the following Websites and Embedded Keywords within a URL
 Allow the following Websites and Embedded Keywords within a URL
 Blocking ALL Internet Access

Website:

Add >>

Example: www.example.com

Embedded keyword within a URL:

<< Remove

Example: "sample" within www.sample.com

- To remove a website or keyword, select the word, then click **Remove**.
- Create a schedule by selecting the days of the week when the rule will be active or inactive.

Create Schedule: [What's this?](#)

Days:

Monday Tuesday Wednesday Thursday Friday Saturday Sunday

Times:

Rule will be Active at the Scheduled Time
 Rule will be Inactive at the Scheduled Time

Start Time:

01 : 00 AM / PM

End Time:

01 : 00 AM / PM

- Set the time when the rule will be active or inactive, then specify the start time and end time.
- Create a rule name and description.

10. Click **Apply** to save changes.

7.1/ RULE SUMMARY

You can view the rules created for your Gateway.

- To view the rule summary, select **Rule Summary**. The Rule Summary page opens with the rule name, description, and computer or device displayed.



Main Wireless Settings My Network Firewall **Parental Controls** Advanced System Monitoring

Main >

Parental Controls >

Rule Summary >

Logout >

Rule Summary

Rule Name	Description	Computer/Device	Enable Rule	View Rule	Edit Rule	Delete Rule
No_BigFish	Block only websites with any of the listed words in their URLs.	HP-Printer	<input checked="" type="checkbox"/>	View	Edit	Remove

Apply >

[Cancel](#) >

You can enable, view, edit, or delete the rule, refer to **Scheduler Rules** for additional setting details.

ACTIVATING ADVANCED PARENTAL CONTROLS

7.2/ ACTIVATING ADVANCED PARENTAL CONTROLS

Verizon is now offering an advanced parental controls solution that offers more robust security features to protect your devices in your home or business. Enter the following URL -

<https://www.verizon.com/home/MLP/router.html>

...to learn more and get started using it today on the My Fios app. The My Fios App' is available to download for free on your mobile devices using Google Play (Android) or the App store (Apple iOS).

Once you have subscribed to Verizon's Advanced Parental Controls, the basic controls available through the router without a subscription to our advanced parental controls solution are disabled but still available to view.



Main Wireless Settings My Network Firewall **Parental Controls** Advanced System Monitoring

- Main >
- Parental Controls >
- Rule Summary >
- Logout >

Advanced Parental Controls

You are subscribed to Verizon's advanced parental controls. To manage advanced parental controls, please use the My Fios app.

The basic controls available through the router without a subscription to our advanced parental controls solution are disabled but still available to view.



Verizon My Fios

The My Fios App is compatible with iPad®, iPhone®, and Android™



Step 1 Select the Primary/Guest Network Device for this Allow or Block Rule.

[What's this?](#)

Primary Network & Guest Network Device

Selected Devices

List

HP-Printer
asus-pc
iPhone

Add >>

<< Remove

Step 2 Create the Parental Control Rules and Schedules.

Limit Access By: [What's this?](#)

- Block the following Websites and Embedded Keywords within a URL.
- Allow the following Websites and Embedded Keywords within a URL.
- Blocking ALL Internet Access.

Website:

Add >>

08/

CONFIGURING ADVANCED SETTINGS

8.0 Using Advanced Settings

8.1 Utilities

8.2 DNS Settings

8.3 Network Settings

8.4 Routing

8.5 Date and Time

8.6 Configuration Settings

Advanced settings cover a wide range of sophisticated configurations for your Gateway's firmware and network.

USING ADVANCED SETTINGS AND UTILITIES

Caution: Many of the settings described in this section should only be configured by experienced network technicians. Changes could adversely affect the operation of your Gateway and local network.

8.0/ USING ADVANCED SETTINGS

You can access the following settings:



Utilities



Date & Time



DNS Settings



Routing



Network Settings



Configuration Settings

To access the advanced settings:

1. Select **Advanced**. A warning page displays, asking if you want to proceed.
2. Click **Yes**. The Advanced page displays.

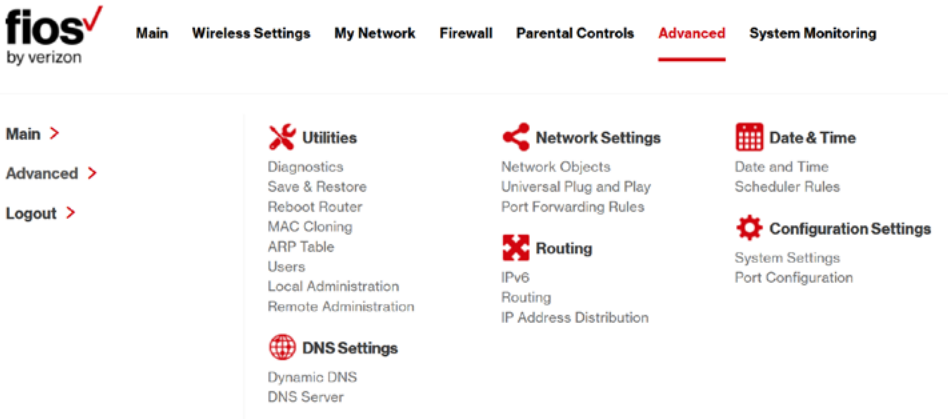

fios
by verizon

Main Wireless Settings My Network Firewall Parental Controls **Advanced** System Monitoring

Main >
Advanced >
Logout >

Utilities
Diagnostics
Save & Restore
Reboot Router
MAC Cloning
ARP Table
Users
Local Administration
Remote Administration

Network Settings
Network Objects
Universal Plug and Play
Port Forwarding Rules

Routing
IPv6
Routing
IP Address Distribution

Date & Time
Date and Time
Scheduler Rules

Configuration Settings
System Settings
Port Configuration

DNS Settings
Dynamic DNS
DNS Server

3. Select a topic by clicking the topic name.

8.1/ UTILITIES

You can access the following advanced settings:

- **Diagnostics** – performs diagnostic tests
- **Save & Restore** – resets your Gateway to its default settings, or backup configurations and restore from select configuration files
- **Reboot Router** – restarts your Gateway
- **MAC Cloning** – clones the MAC address
- **ARP Table** – displays active devices with their IP and MAC addresses
- **Users** – provides the ability to edit router administrator settings

UTILITIES

- **Local Administration** – allows you to grant local SSH access
- **Remote Administration** – detailed in Chapter 6 Configuring Your Network Settings

8.1a/ DIAGNOSTICS

You can use diagnostics to test network connectivity.

To diagnose network connectivity:

1. Select **Diagnostics** in the Advanced page.

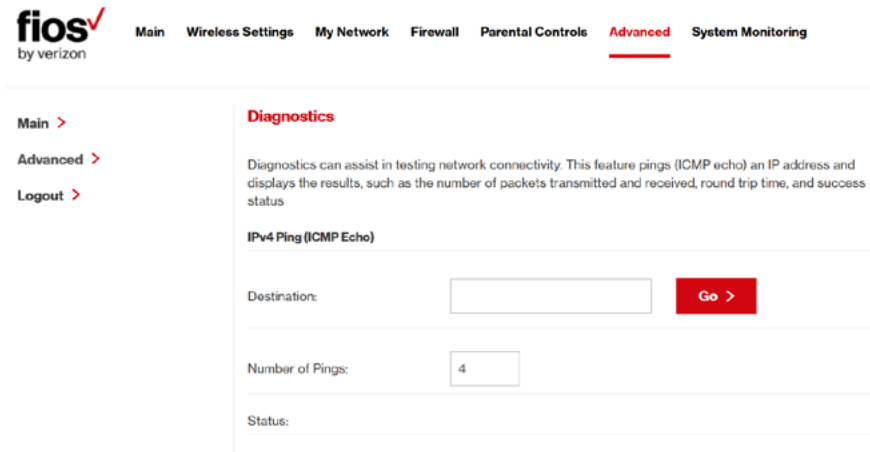

The screenshot shows the Fios by Verizon Advanced page. The navigation menu includes Main, Wireless Settings, My Network, Firewall, Parental Controls, **Advanced**, and System Monitoring. The left sidebar has links for Main >, **Advanced >**, and Logout >. The main content area is titled **Diagnostics** and contains the following text: "Diagnostics can assist in testing network connectivity. This feature pings (ICMP echo) an IP address and displays the results, such as the number of packets transmitted and received, round trip time, and success status". Below this is the "IPv4 Ping (ICMP Echo)" section with a form containing three fields: "Destination:" with an empty text input box and a red "Go >" button; "Number of Pings:" with a text input box containing the number "4"; and "Status:" with an empty text input box.

2. To ping an IP address, enter the IP address or domain name in the **Destination** field and click **Go**.

The diagnostics will display the number of pings, status, packets sent, and round trip time.

If no diagnostic status displays, click **Refresh** in your web browser.

3. Click **Close** to exit the session.

8.1b/ SAVE & RESTORE

SAVE & RESTORE ROUTER CONFIGURATION

Saving your router configuration allows you to backup and save your custom settings, such as Wi-Fi names, passwords, DNS Settings, Firewall, Port Forwarding Rules, etc. The router's configuration file can be saved to the router, to a computer or to your account, to be used in the event changes are made which make the router perform poorly or in the case of a device change.

The screenshot shows the Fios by Verizon website interface. At the top left is the Fios logo. A navigation bar contains the following items: Main, Wireless Settings, My Network, Firewall, Parental Controls, **Advanced** (highlighted with a red underline), and System Monitoring. On the left side, there is a sidebar menu with 'Main >', 'Advanced >', and 'Logout >'. The main content area is titled 'Save & Restore Router Configuration' in red. Below the title, there is a paragraph explaining that saving the configuration allows for backup of custom settings like Wi-Fi names, passwords, DNS settings, and firewall rules. Underneath, there is a section for 'Save Options' with two radio buttons: 'Save to router and VZ Cloud' (which is selected) and 'Save as a File'. At the bottom of this section is a red button labeled 'Save configuration >'.

UTILITIES

SAVE OPTIONS

You can use one of the save configuration options to save/backup your router's current configuration file, to load and restore from at a later time. Refer to the image below for an example of the save options.

SAVE TO ROUTER AND VZ CLOUD

To save your router's current configuration locally onto your router and/or to the VZ Cloud:

1. Select the **Save to router and VZ Cloud** option
2. Click the **Save configuration** button. When the save is complete you will see **Save Status : Success**
3. Refer to the **Manual Backup** dropdown file list to see the date and time of the newly saved router configuration file

Note: To view the manual backup file be sure to refresh the page.

SAVE AS A FILE

To save your router's current configuration to your computer

1. Select the **Save as a File** option
2. Click the **Save Configuration** button
3. The new configuration file will be saved to your web browser's download folder

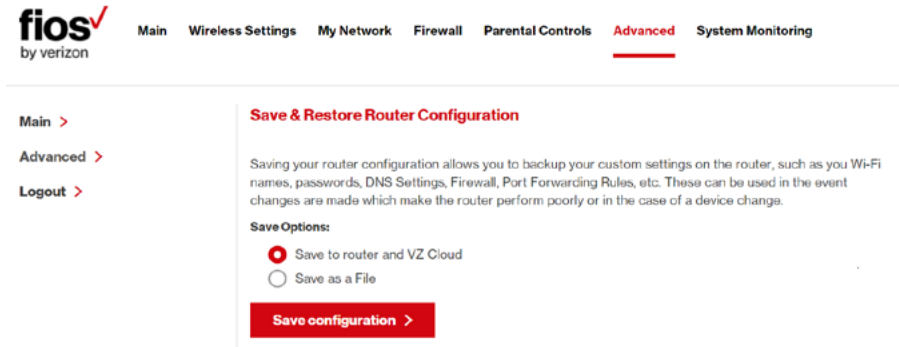

RESTORE OPTIONS

You can use one of the restore configuration options to select and load a previously saved router configuration file. These files are used to restore the selected configuration of your router from a previous backup based on date and time, saved to your account, the router, a computer where a configuration file was saved. It can also be used to restore factory defaults.

A saved configuration file can also be loaded on a new BHR4 from your My Verizon account.

Restoring to a previously saved configuration setting will erase the current configuration of the router. Refer to the image below for an example of the restore options.

Note: Only configuration files saved on a specific router can be applied to that router. You cannot transfer or share configuration files between other routers, or different router models.

UTILITIES

Warning: Manually editing a configuration file can cause your Gateway to malfunction or become completely inoperable.

The screenshot shows the 'Restore Options' section of a router's configuration page. It features several radio button options: 'Automated Backups' (selected), 'Manual Backup', 'Restore Factory Defaults' (highlighted with a red dot), 'Load A File', and 'Restore From Account'. To the right of the 'Automated Backups' option is a dropdown menu showing '03/29/2018 @ 4:02 am'. Below the 'Restore Factory Defaults' option is a dropdown menu showing 'Default Settings'. A warning message states: 'Restoring to factory defaults or to a previously saved configuration setting will erase the current configuration of the router. Use this option to return to an out of box state or a known working setup.' Below this, there is a note: 'To complete this action, use the My Fios App or My Verizon account to view your recently saved settings and restore them to the router.' This is followed by the 'Verizon My Fios' logo and text: 'The My Fios App is compatible with iPad®, iPhone®, and Android®'. There are also 'Available on the App Store' and 'GET IT ON Google play' logos. At the bottom, there is a red button labeled 'Restore configuration >'.

AUTOMATED BACKUPS

The Automated Backups feature will save a copy of your router's current configuration settings to your My Verizon account (on the 1st, 8th, 15th, 22nd and 29th of each month). You can then, select one of the Automated Backups configuration files to restore your router to.

*To load or restore from a previous **Automated Backup** configuration file:*

1. Select the **Automated Backups** from the Restore Options
2. Select a backup file from the drop-down list
3. Click the **Restore configuration** button

- Checking the 'Disable & Delete Automated Backups' will disable the automated backup function and remove all previously saved automated backup files
- Unchecking the 'Disable & Delete Automated Backups' will enable the automated backup

Note: When you initially receive your router and the first Automatic Backup has not yet occurred, your router will display 'Not Available'.

MANUAL BACKUP

*To load or restore from a previous **Manual Backup** configuration file:*

1. Select the **Manual Backup** from the Restore Options.
2. Click the **Restore configuration** button.

LOAD A FILE

To load or restore from a previously saved configuration file that was saved to your computer:

1. Select the **Load A File** from the Restore Options
2. Click the **Restore configuration** button
3. Browse to the location of the file, then click **Apply** to begin the configuration uploading process. Your Gateway will automatically restart with that configuration.

UTILITIES

RESTORE FROM ACCOUNT

To load or restore from a configuration file previously saved to **your Account**:

1. Select the **Restore From Account** from the Restore Options
2. Click the **Restore configuration** button
3. To complete the **Restore From Account** option, use the My Fios App or your My Verizon account to view your recently saved settings and restore them to the router.

RESTORE FACTORY DEFAULTS

You can restore your configuration settings to your router factory default settings. Restoring the default settings erases the current configuration, including user defined settings and network

connections. All connected DHCP client must request new IP addresses. Your Gateway must restart.

Prior to restoring the factory defaults, you may want to save your current configuration to a file. This allows you to reapply your current settings and parameters to the default settings, as needed.

Use this option to return to an out of box state or a known working setup.

Note: When restoring defaults, the setting and parameters of your router are restored to their default values. This includes the Administrator password. A user-specified password will no longer be valid. All saved automatic and manual backup configuration files will also be deleted. If needed, be sure to save your configuration file to a local computer or to your VZ account before performing the restore factory defaults.

To restore the router to **Factory Default** settings:

1. Select the **Restore Factory Default** from the Restore Options
2. Select the either the **Factory Default** (Restores Gateway to Out of Box settings) or **Default Settings** except current user settings (restores all settings except SSIDs, passwords, etc.) from the dropdown menu.
3. Click the **Restore configuration** button. The factory default settings will be applied, and your router will restart. Once complete, the Login page for the **First Time Easy Setup Wizard** will display.

8.1c/ REBOOT GATEWAY

You can reboot your Gateway using the Reboot Router feature as well as pressing and holding the WPS button on the front of the Gateway for at least 10 seconds.

To reboot your Gateway:

1. Select **Reboot Router** in the Advanced page.

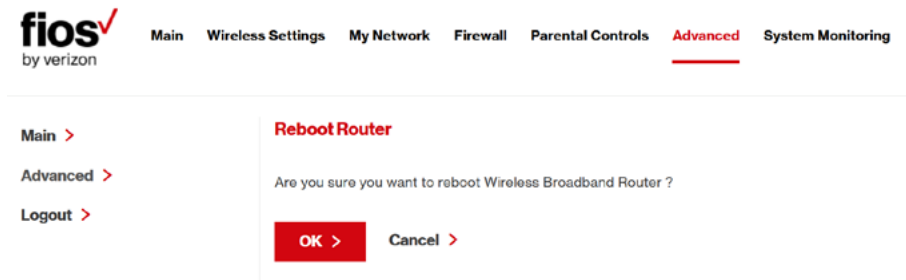

UTILITIES

2. To reboot, click **OK**. Your Gateway reboots. This may take up to a minute.
3. To access your Gateway user interface, refresh your web browser.

8.1d/ MAC CLONING

A MAC address is a hexadecimal code that identifies a device on a network. All networkable devices have a unique MAC address.

When replacing a network device on your Gateway, you can simplify the installation process by copying the MAC address of the existing device to your Gateway.

To copy the MAC address of the existing device:

1. Select **MAC Cloning** in the Advanced page.

The screenshot shows the Fios Gateway user interface. At the top left is the Fios by Verizon logo. A navigation bar contains the following items: Main, Wireless Settings, My Network, Firewall, Parental Controls, **Advanced** (highlighted with a red underline), and System Monitoring. On the left side, there is a sidebar menu with 'Main >', 'Advanced >' (highlighted), and 'Logout >'. The main content area is titled 'MAC Cloning' in red. Below the title, a paragraph explains: 'MAC Address Cloning provides the ability to emulate the routers MAC address to appear identical to the original hardware address. Use this feature only if your ISP requires MAC Address authentication'. There are two radio buttons: 'Set MAC of Device:' and 'Broadband Connection(Ethernet)'. The 'Broadband Connection(Ethernet)' option is selected. Below this, the 'To Physical Address:' field shows a hexadecimal MAC address: 'c8 : a7 : 0a : 82 : 09 : 11'. At the bottom right of the form is a red button labeled 'Restore factory MAC address >'. At the very bottom of the page are two buttons: 'Apply >' and 'Cancel >'.

2. In the **To Physical Address** field, enter the MAC address of your new device.
3. To locate the MAC address, refer to the documentation from the device manufacturer.
4. Click **Apply** to save changes.

8.1e/ ARP TABLE

You can view the IP and MAC addresses of each DHCP connection.

To view the IP and MAC addresses:

1. Select **ARP Table**.

The screenshot shows the Fios Advanced Settings interface. The navigation menu includes Main, Wireless Settings, My Network, Firewall, Parental Controls, **Advanced** (highlighted with a red underline), and System Monitoring. On the left sidebar, there are links for Main >, Advanced >, and Logout >. The main content area is titled **ARP Table** and contains the text: "The ARP Table below displays the IP and MAC address of each DHCP connection". Below this text is a table with three columns: IP Address, MAC Address, and Device. The table lists four DHCP connections.

IP Address	MAC Address	Device
71.87.238.1	00:23:df:0d:bc:a9	Broadband Connection (Ethernet/Coax)
192.168.1.10	3c:49:05:04:d7:42	Network (Home/Office)
192.168.1.168	48:5b:39:23:5a:43	Network (Home/Office)
192.168.1.7	24:a2:b1:07:a8:99	Network (Home/Office)

2. Review the IP and MAC address for each device.
3. When complete, click **Close**.

UTILITIES

8.1f/ USERS

You can view the users that can currently access your wireless network. In addition, you can modify their login password and name as well as manage the number of unsuccessful login attempts a user can enter before your Gateway temporarily denies all further login attempts by that user.

To view users:

1. Select **Users** in the Advanced page.

The screenshot shows the fios by verizon router configuration interface. The top navigation bar includes links for Main, Wireless Settings, My Network, Firewall, Parental Controls, **Advanced** (highlighted with a red underline), and System Monitoring. On the left, a sidebar menu shows Main >, **Advanced >**, and Logout >. The main content area is titled **Users** and contains the following information:

The User page provides the ability to edit router administrator settings.

Login Configuration

Maximum Unsuccessful Login Attempts:

Users

Full Name	User Name	Permissions	Action
Administrator	admin	Administrator	Edit

At the bottom of the Users section, there are two buttons: **Apply >** and **Close >**.

2. In the **Login Configuration** section, enter the maximum number of unsuccessful login attempts.
3. To edit usernames and passwords, click the **Edit** icon in the **Action** column. The User Settings page displays.

fios
by verizon

Main Wireless Settings My Network Firewall Parental Controls **Advanced** System Monitoring

Main >
Advanced >
Logout >

User Settings

General

Full Name:

User Name (case sensitive):

Set a new password
[Tips for creating secure passwords](#)

Permissions:

Apply > **Cancel >**

- To edit the Administration Name and set a new password, as needed.
 - Full Name** - name of the user.
 - User Name** – the User Name 'admin' is unchangeable.
- To set a new Password, select the **Set a new password** check box. The **New Password** fields display.
- Click **Apply** to save changes. The Users page opens with the user information displayed.
- Click **Apply** again to save changes and exit.

UTILITIES AND DNS SETTINGS

8.1g/ LOCAL ADMINISTRATION

You can grant local access on a specific port.

To grant access:

1. Select **Local Administration** in the Advanced page.

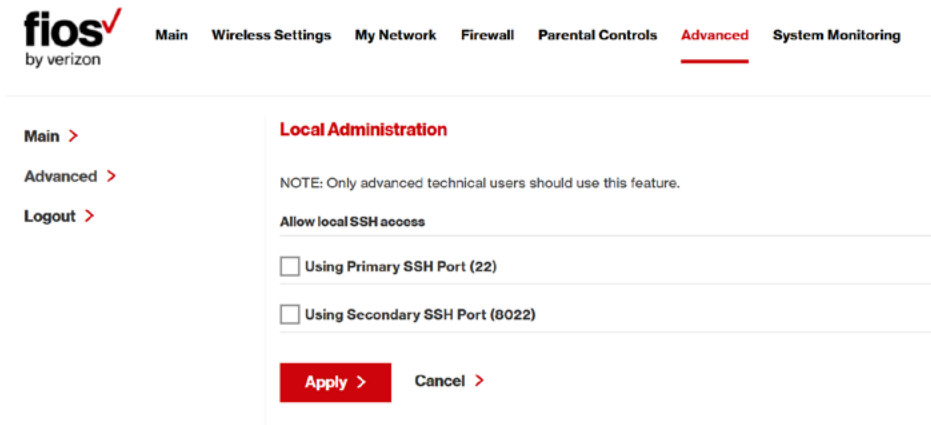

2. To grant access, select the check box for the specific SSH access.
3. Click **Apply** to save changes. Local access is granted.
4. To remove access, clear the checkbox, then click **Apply**. No local access is granted.

8.1h/ REMOTE ADMINISTRATION

The Remote Administration parameters are detailed in **Chapter 6 under Firewall Settings**.

8.2/ DNS SETTINGS

You can view and manage the DNS server host name and IP address as well as add a new computer. The DNS server does not require configuration.

8.2a/ DYNAMIC DNS

Typically, when connecting to the Internet, your router is assigned an unused public IP address from a pool, and this address changes periodically.

Dynamic DNS allows a static domain name to be mapped to the dynamic IP address, allowing a computer within your network to be more easily accessible from the Internet.

When using Dynamic DNS, each time the public IP address changes, the DNS database is automatically updated with the new IP address. In this way, even though the IP address changes often, the domain name remains constant and accessible.

To set up dynamic DNS:

1. **Select Dynamic DNS**

DNS SETTINGS

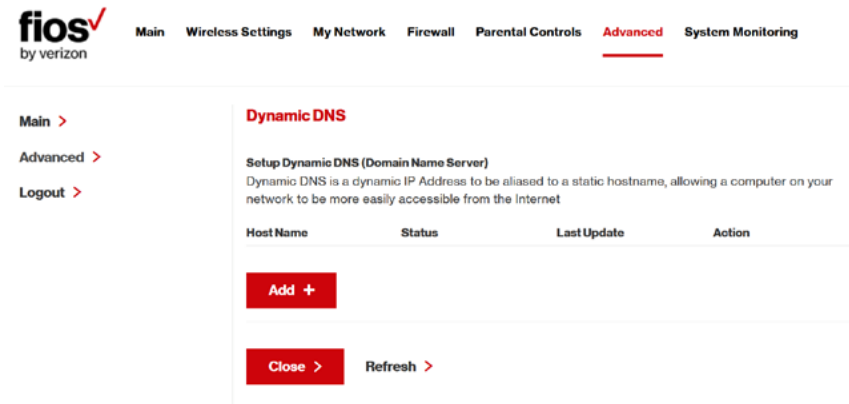

fios by verizon

Main Wireless Settings My Network Firewall Parental Controls **Advanced** System Monitoring

Main >
Advanced >
Logout >

Dynamic DNS

Setup Dynamic DNS (Domain Name Server)
Dynamic DNS is a dynamic IP Address to be aliased to a static hostname, allowing a computer on your network to be more easily accessible from the Internet

Host Name	Status	Last Update	Action
Add +			

[Close >](#) [Refresh >](#)

2. To set up a new entry, click the **Add** button.

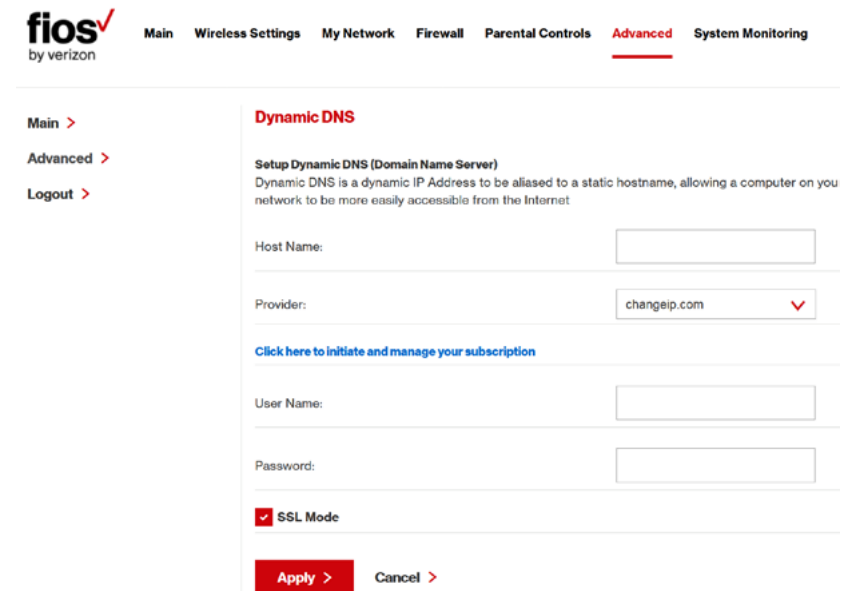

fios by verizon

Main Wireless Settings My Network Firewall Parental Controls **Advanced** System Monitoring

Main >
Advanced >
Logout >

Dynamic DNS

Setup Dynamic DNS (Domain Name Server)
Dynamic DNS is a dynamic IP Address to be aliased to a static hostname, allowing a computer on your network to be more easily accessible from the Internet

Host Name:

Provider:

[Click here to initiate and manage your subscription](#)

User Name:

Password:

SSL Mode

[Apply >](#) [Cancel >](#)

3. Configure the following parameters:

- **Host Name** – enter the full domain name for your Dynamic DNS domain.
- **Provider** – select the Dynamic DNS account provider from the menu.
- **User Name** – enter your user name for your Dynamic DNS account.
- **Password** – enter the password for your Dynamic DNS account.
- **SSL Mode** – select if your Dynamic DNS service supports SSL.

Click **Apply** to save your changes.

To edit the host name or IP address:

1. In the Action column, click the Edit icon. The DNS Entry page displays.
2. Edit the settings.
3. Click **Apply** to save the changes.

8.2b/ DNS SERVER

You can edit the host name and/or IP address, if the host was manually added to the DNS table. If not, you can not edit the entry.

DNS SETTINGS AND NETWORK SETTINGS

To access the DNS server:

1. Select **DNS Server** in the Advanced page.

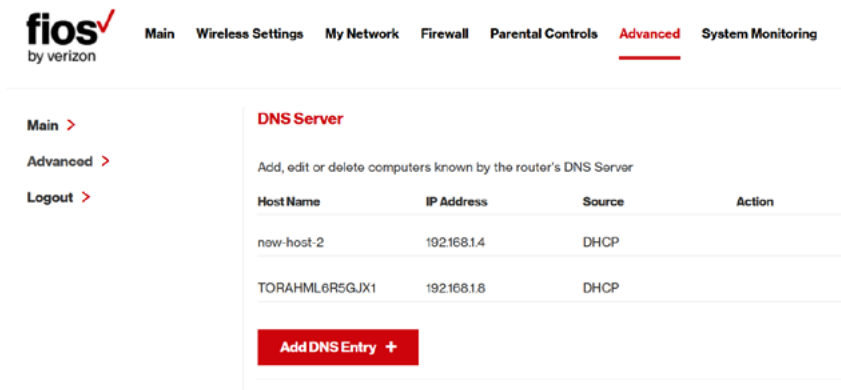

2. To view and add computers stored in the DNS table, click **Add DNS Entry**. The Add DNS Entry page displays.
3. In the **Host Name** field, enter the name of the computer, then enter the IP address and click **Apply** to save changes. The DNS Server page displays.
4. To edit the host name or IP address, click the **Edit** icon in the **Action** column. The DNS Entry page displays. Edit the host name and/or IP address, then click **Apply** to save changes.
5. To remove a host from the DNS table, click the **Remove** icon in the **Action** column.

8.3/ NETWORK SETTINGS

You can configure the following network settings:

- **Network Objects** – define a group, such as a group of computers
- **UPnP** – checks the validity of all UPnP services and rules
- **Port Forwarding Rules** – displays port forwarding rules

8.3a/ NETWORK OBJECTS

Network objects define a group, such as a group of computers, on your Gateway network by MAC address, IP address, and /or host name. The defined group becomes a network object. You can apply settings, such as configuring system rules, to all devices defined in the network object.

For example, instead of setting the same website filtering configuration individually to five computers one at a time, you can define the computers as a network object. Website filtering can then be simultaneously applied to all the computers.

You can use network objects to apply security rules based on host names, instead of IP addresses. This is useful since IP addresses change from time to time. In addition, you can define network objects according to MAC address to make the rule application more persistent against network configuration settings.

To define a network object:

1. Select **Network Objects** in the Advanced page.

NETWORK SETTINGS



- Main >
- Advanced >
- Logout >

Network Objects

A Network Object is a set of host names, IP addresses, or MAC addresses. Security rules can be applied to a distinct LAN subnet using Network Objects.

Network Object	Items	Action
Example One	192.233.31.31 192.168.1.1 / 255.255.255.255 10.0.0.10 - 10.0.7.200	Edit Remove

Add +

Close >

- To define a network object, click **Add**. The Edit Network Objects page displays.



- Main >
- Advanced >
- Logout >

Edit Network Objects

Network Object

Description

Global Object

Items

Item

Action

Add +

Apply > Cancel >

3. In the **Description** field, enter a name for the network object.
4. Click **Add**. The Edit Item page displays.

The screenshot shows the Fios by Verizon interface. At the top, there is a navigation menu with the following items: Main, Wireless Settings, My Network, Firewall, Parental Controls, **Advanced** (highlighted with a red underline), and System Monitoring. On the left side, there is a sidebar with links: Main >, Advanced >, and Logout >. The main content area is titled 'Edit Item' and contains the following fields and buttons:

- Network Object Type:** A dropdown menu currently showing 'IP Address' with a red downward arrow.
- IP Address:** A field with four input boxes, each containing the digit '0', separated by dots.
- Buttons:** A red 'Apply >' button and a 'Cancel >' button.

5. Select the type of network object as IP address, IP subnet, IP range, MAC address, host name, DHCP option, or protocol, and click **Apply** to save changes.
6. Repeat the above steps to create additional network objects.
7. When complete, click **Apply** to save changes.

8.3b/ UNIVERSAL PLUG AND PLAY

You can use Universal Plug and Play (UPnP) to support new devices without configuring or rebooting your Gateway.

In addition, you can enable the automatic cleanup of invalid rules.

NETWORK SETTINGS

When enabled, this functionality verifies the validity of all UPnP services and rules every five minutes. Old and unused UPnP defined services are removed, unless a user-defined rule depends on it.

UPnP services are not deleted when disconnecting a computer without proper shutdown of the UPnP applications, such as messenger. Services may often not be deleted and eventually this leads to the exhaustion of rules and services, and no new services can be define. The cleanup feature locates the invalid services and removes them, preventing services exhaustion.

To access *this setting*:

1. Select **Universal Plug and Play** in the Advanced page.

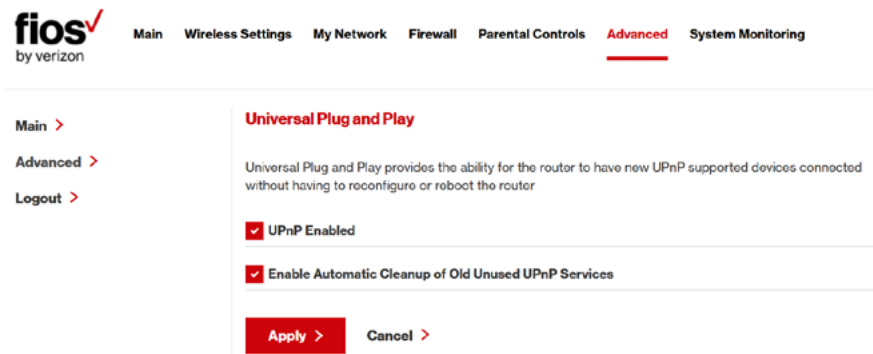

2. To enable UPnP and allow UPnP services to be defined on any network hosts, select the **UPnP Enabled** check box.
3. To enable automatic cleanup of invalid rules, select **Enable Automatic Cleanup of Old Unused UPnP Services** check box.
4. Click **Apply** to save changes.

8.3c/ PORT FORWARDING RULES

You can view, modify, and delete port forwarding rules.

To access the rules:

1. Select **Port Forwarding Rules** in the Advanced page.

The screenshot shows the Fios Advanced settings page. The navigation bar includes: Main, Wireless Settings, My Network, Firewall, Parental Controls, **Advanced** (highlighted with a red underline), and System Monitoring. On the left, there is a sidebar with links: Main >, Advanced >, and Logout >. The main content area is titled "Port Forwarding Rules" and contains the following text: "Below is a list of currently configured Protocols that are implemented in the Wireless Broadband Router." Below this text is a table with three columns: Protocols, Ports, and Action. The table lists various protocols and their corresponding port ranges, with an "Edit Remove" link for each row. At the bottom of the table is a red "Add +" button.

Protocols	Ports	Action
FTP	TCP Any -> 21	Edit Remove
HTTP	TCP Any -> 80	Edit Remove
HTTPS	TCP Any -> 443	Edit Remove
IMAP	TCP Any -> 143	Edit Remove
L2TP	UDP Any -> 1701	Edit Remove
Ping	ICMP Echo Request	Edit Remove
POP3	TCP Any -> 110	Edit Remove
SMTP	TCP Any -> 25	Edit Remove
SNMP	UDP Any -> 161	Edit Remove
Telnet	TCP Any -> 23	Edit Remove
TFTP	UDP 1024 - 65535 -> 69	Edit Remove
Traceroute	UDP 32769 - 65535 -> 33434 - 33523	Edit Remove

[Add +](#)

NETWORK SETTINGS AND ROUTING

2. To edit a protocol rule, click the **Edit** icon in the **Action** column. The Edit Service page displays.

The screenshot shows the 'Edit Service' page in the fios by verizon network settings interface. The top navigation bar includes 'Main', 'Wireless Settings', 'My Network', 'Firewall', 'Parental Controls', 'Advanced' (highlighted with a red underline), and 'System Monitoring'. On the left, there is a sidebar with 'Main >', 'Advanced >', and 'Logout >'. The main content area is titled 'Edit Service' and contains the following elements:

- Service Name:** A text input field containing 'FTP'.
- Service Description:** A text input field containing 'File Transfer'.
- Server Ports:** A table with the following structure:

Protocol	Server Ports	Action
TCP	Any -> 21	Edit Remove
- Add server ports +**: A red button with a plus sign.
- Apply >** and **Cancel >**: Two buttons at the bottom.

3. Modify the **Service Name** and **Service Description**, as needed.
4. To modify the current protocol, click the **Edit** icon in the Action column.
5. To add server ports, click **Add Server Ports**.
6. Click **Apply** to save changes.

8.4/ ROUTING

You can configure the following settings:

- **IPv6** – enables IPv6 support.
- **Routing** – manages the routing and IP address distribution rules.
- **IP Address Distribution** - adds computers configured as DHCP clients to the network

8.4a/ IPv6

Use the IPv6 feature settings to enable, disable, or configure an IPv6 Internet connection and IPv6 LAN settings.

1. To configure your network to use the IPv6 Internet connection type. Select IPv6 from the Advanced page to display the IPv6 service options:



Main Wireless Settings My Network Firewall Parental Controls **Advanced** System Monitoring

Main >
Advanced >
Logout >

 **Utilities**
Diagnostics
Save & Restore
Reboot Router
MAC Cloning
ARP Table
Users
Local Administration
Remote Administration

 **DNS Settings**
Dynamic DNS
DNS Server

 **Network Settings**
Network Objects
Universal Plug and Play
Port Forwarding Rules

 **Routing**
IPv6
Routing
IP Address Distribution

 **Date & Time**
Date and Time
Scheduler Rules

 **Configuration Settings**
System Settings
Port Configuration

ROUTING

2. Select **Enable** under the Enable IPv6 Support option. (Once IPv6 is enabled the default setting will be IPv6 WAN as DHCPv6-PD and IPv6 LAN as Stateless).

IPv6 Configuration Control

1. Enable IPv6 Support

Enabled Disabled

2. Specify the method to be used to obtain your WAN IPv6 Address

IPv6 WAN Configuration: ▼

WAN Prefix: 2600::/56

Expires In: Expired

Prefix Lifetime: Release > Renew >

WAN Link-Local Address: fe80::2a00:2a00::1

Obtain IPv6 DNS Server address automatically
 Use the following IPv6 DNS Server addresses

3. Select the appropriate IPv6 connection **method** from the drop-down list, as shown below to specify the method to be used to obtain your WAN IPv6 Address.

2. Specify the method to be used to obtain your WAN IPv6 Address

IPv6 WAN Configuration:

WAN Prefix:

Expires In:

4. Click Apply to have changes take effect.

Note: "IPv6 settings will only be displayed if the IPv6 feature has been 'Enabled'. In addition, Guest Wi-Fi clients are not currently supported by the IPv6 feature.

- To disable the IPv6 service click on the “Disable” option as shown below and click **Apply** to have changes take effect.

IPv6 Configuration Control

1. Enable IPv6 Support

Enabled Disabled

Once configured using your valid IPv6 WAN and LAN configurations you should not see any errors when you click on the “Apply” button. The Main page will reflect the router’s new IPv6 address as shown below.

The screenshot shows the fios by verizon router configuration interface. The navigation bar includes: Main, Wireless Settings, My Network, Firewall, Parental Controls, Advanced, and System Monitoring. The main content area is divided into three sections: Status, My Network, and Verizon Zone.

- Status:** Router Status: Connected. Ethernet Status: Connected. IPv4 Connection Type: DHCP. IPv4 Address: 71.177.208.88. IPv6 Connection Type: DHCPv6-PD. IPv6 Address: 2600:a00:6300:0000:0000:0000:0000:0000. A red arrow points to the IPv6 address with the text: "Once enabled and configured your IPv6 address will show here".
- My Network:** Primary Network. TORAHML6R5GJX1. Connected To: FIOS_Quantum_Gat... Connection: Wireless 2.4G. Connection Type: 802.11b. IPv4 Address: 192.168.1.8. IPv6 Global: 2600:0000:0000:0000:0000:0000:0000:0000. IPv6 Link-Local: fe80:0000:0000:0000:0000:0000:0000:0000. Status: Active.
- Verizon Zone:** Verizon.com >, My Verizon Account >, My Business Account >, Support >, Watch TV Online >.

You should also see the IPv6 address for all IPv6 supported devices on your local network displayed on the My Network page and under the Broadband Connection (Ethernet/Coax) Properties as shown on the two pages below.

ROUTING



Main Wireless Settings **My Network** Firewall Parental Controls Advanced System Monitoring

- Main >
- Network Status >
- Network Connections >
- Logout >

My Network

Connected Devices

Primary Network [Show More](#)



TORAHML6R5GJX1

Device Options



Connected To: FIOS_Quantum_Gateway
Connection: Wireless 2.4G
Connection Type: 802.11b ▲
IPv4 Address: 192.168.1.8
IPv4 Address Allocation: DHCP
IPv6 Global: 2600:519c:65a2:2304:519c:
IPv6 Link-Local: fe80::519c:65a2:2304:519c
IPv6 Address Allocation: Stateless
MAC Address: 6c:8e:68:50:82:8e
Status: Active

Ethernet: 3
Wireless 5G: 2
Wireless 2.4G: 2
Coax: 1

- Main >
- Network Status >
- Network Connections >
- Logout >

Broadband Connection (Ethernet/Coax) Properties

Note: Only advanced technical users should use this feature.

[Disable >](#)

Name:	Broadband Connection (Ethernet/Coax)
Status:	Connected
Network:	Broadband Connection
Connection Type:	Ethernet/Coax
MAC Address:	c8:a8:68:50:82:8e
IP Address:	71:1:1:1:1:1
Subnet Mask:	255.255.255.0
Default Gateway:	192.168.1.1
DNS Servers:	192.168.1.1 68:51:9c:65:a2:23:04:51:9c
IP Address Distribution:	Disabled
IPv6 Address:	2600:519c:65a2:2304:519c:65a2:2304:519c

STATIC - WAN IPv6 ADDRESS CONNECTION

The IPv6 WAN Static configurations are IPv6 settings that you enter manually. These specific IPv6 addresses and settings are not expected to change frequently.

1. To configure IPv6 WAN **Static** mode, select the Static option on the IPv6 Configuration Control Page as shown:

fios
by verizon

Main Wireless Settings My Network Firewall Parental Controls **Advanced** System Monitoring

Main >
Advanced >
Logout >

IPv6 Configuration Control

1. Enable IPv6 Support
 Enabled Disabled

2. Specify the method to be used to obtain your WAN IPv6 Address

IPv6 WAN Configuration:	Static
IPv6 WAN Address:	2001:0:9d:30:6:6ad:303a:42f7:3ad
Prefix Length:	48
Default Gateway:	2001:0d:3b:ffff:
Primary DNS Server:	2001:4860:4860:4860:
Secondary DNS Server:	2001:4860:4860:4860:

2. Specify the **Static** method to be used to obtain your WAN IPv6 Address by entering:
 - **IPv6 WAN Configuration (select Static)** as shown in drop-down list and page below:

ROUTING

2. Specify the method to be used to obtain your WAN IPv6 Address

IPv6 WAN Configuration:	<input type="radio"/> None
IPv6 WAN Address:	<input checked="" type="radio"/> Static
Prefix Length:	<input type="radio"/> DHCPv6-PD

- **IPv6 WAN Address**
 - **Prefix Length** (*A numeric value between 16 and 128*)
 - **Default Gateway**
 - **Primary DNS Server**
 - **Secondary DNS Server**
3. After entering all appropriate IPv6 settings click Apply to have changes take effect.

STATIC - WAN IPv6 ADDRESS CONNECTION

1. To configure IPv6 LAN Stateful mode with Static WAN, select the Stateful (DHCPv6) option on the IPv6 Configuration Control Page as shown below:

3. Specify the method to be used to assign LAN IPv6 addresses

IPv6 LAN Configuration:	<input type="radio"/> Stateless (DHCPv6)	<input checked="" type="radio"/> Stateful (DHCPv6)
LAN Prefix:	<input type="text"/>	
LAN IPv6 Address Range:	<input type="text" value="2"/>	<input type="text" value="ffff"/>
LAN Link-Local Address:	<input type="text" value="fe80-ca::a9"/>	
Router Advertisement Lifetime:	<input type="text" value="7"/>	minutes (0-150)
IPv6 Address Lifetime:	<input type="text" value="30"/>	minutes (3-150)

2. Specify the **Stateful (DHCPv6)** settings to be used to assign LAN IPv6 addresses by entering the following details:

- **IPv6 LAN Configuration** (select **Stateful** from the drop-down list) as shown in drop-down list and page below:

3. Specify the method to be used to assign LAN IPv6 addresses

IPv6 LAN Configuration:	<input checked="" type="radio"/> Stateful (DHCPv6)
LAN Prefix:	<input type="radio"/> Stateless
LAN IPv6 Link Local Address:	<input type="text" value="FE80::0000:0000:0000:0000"/>

- **LAN Prefix**
- **LAN IPv6 Link Local Address** (automatically populated)
- **LAN IPv6 Address Range** (*start and end*)
- **Router Advertisement Lifetime** (*minutes between 0-150*)
- **IPv6 Address Lifetime** (*minutes between 3-150*)
- **Interfaces** - check one or more of the box(s) to apply IPv6 LAN settings to the selected interfaces:
 - Ethernet IPv6 Enabled
 - Wireless Access Point 1 IPv6 Enabled
 - Wireless Access Point 2 IPv6 Enabled
 - Coax IPv6 Enabled

ROUTING

3. After entering all appropriate IPv6 settings click Apply to have changes take effect.

STATIC WAN WITH LAN IPv6 STATELESS SETTINGS:

1. To configure LAN IPv6 Stateless mode with **Static WAN**, select the Stateless option on the IPv6 Configuration Control Page as shown below:

3. Specify the method to be used to assign LAN IPv6 addresses

IPv6 LAN Configuration: Stateless

LAN Prefix: fec0::1/64

LAN IPv6 Link Local Address: fe80::ca97:adff:fe02:912

Router Advertisement Lifetime: 3 minutes (0-150)

Interfaces

- Ethernet IPv6 Enabled
- 5.0GHz Wireless Access Point 1 IPv6 Enabled
- 2.4GHz Wireless Access Point 2 IPv6 Enabled
- Coax IPv6 Enabled

2. Specify the settings to be used to assign LAN IPv6 addresses by entering the following details:
 - **IPv6 LAN Configuration** (select **Stateless** from the drop-down list) as shown in drop-down list below:

3. Specify the method to be used to assign LAN IPv6 addresses

IPv6 LAN Configuration:

LAN Prefix:

LAN IPv6 Link Local Address:

- **LAN Prefix**
- **LAN IPv6 Link Local Address** (*automatically populated*)

- **Router Advertisement Lifetime** (*minutes between 0-150*)
 - **Interfaces** - check one or more of the box(s) to apply IPv6 LAN settings to the selected interfaces:
 - Ethernet IPv6 Enabled
 - Wireless Access Point 1 IPv6 Enabled
 - Wireless Access Point 2 IPv6 Enabled
 - Coax IPv6 Enabled
3. After entering all appropriate IPv6 settings click Apply to have changes take effect.

DHCPv6-PD - WAN IPv6 ADDRESS CONNECTION

The IPv6 WAN DHCPv6-PD configurations are IPv6 settings that you enter that will allow your IPv6 connection to be updated by the ISP as needed.

1. To configure IPv6 WAN Stateful (DHCPv6-PD) mode, select the Stateful (DHCPv6-PD) option on the IPv6 Configuration Control Page as shown below:

The screenshot shows the Fios Advanced Settings page for IPv6 Configuration Control. The navigation bar includes: Main, Wireless Settings, My Network, Firewall, Parental Controls, **Advanced**, and System Monitoring. The left sidebar has: Main >, Advanced >, and Logout >. The main content area is titled "IPv6 Configuration Control" and contains two steps:

1. Enable IPv6 Support
 Enabled Disabled
2. Specify the method to be used to obtain your WAN IPv6 Address
IPv6 WAN Configuration:

ROUTING

2. Specify the DHCPv6-PD method to be used to obtain your WAN IPv6 Address by entering:
 - **IPv6 WAN Configuration** (select **DHCPv6** from the drop-down list) *as shown in drop-down list and page below:*

2. Specify the method to be used to obtain your WAN IPv6 Address

IPv6 WAN Configuration:

WAN Prefix:

Expires In:

None
Static
<input checked="" type="checkbox"/> DHCPv6-PD

3. Check to either 'Obtain IPv6 DNS Server address automatically', or to 'Use the following IPv6 DNS Server addresses'
4. After entering all appropriate IPv6 settings click Apply to have changes take effect.

DHCPv6-PD WAN WITH LAN IPv6 STATEFUL (DHCPv6) SETTINGS:

1. To configure IPv6 LAN Stateful (DHCPv6-PD) mode, select the Stateful (DHCPv6-PD) option on the IPv6 Configuration Control Page as shown below:

3. Specify the method to be used to assign LAN IPv6 addresses

IPv6 LAN Configuration:	<input type="text" value="Stateful (DHCPv6)"/>
LAN Prefix:	<input type="text" value="2000::/64"/>
LAN IPv6 Address Range:	<input type="text" value="2"/> - <input type="text" value="ffff"/>
LAN Link-Local Address:	<input type="text" value="fe80::c000:1000:0:0"/>
Subnet ID:	<input type="text" value="0"/>
Router Advertisement Lifetime:	<input type="text" value="3"/> minutes (0-150)

2. Specify the Stateful (DHCPv6) settings to be used to assign LAN IPv6 addresses by entering the following details:

- **IPv6 LAN Configuration** (select **Stateful** from the drop-down list) as shown in drop-down list and page below:

3. Specify the method to be used to assign LAN IPv6 addresses

IPv6 LAN Configuration:	<input checked="" type="radio"/> Stateful (DHCPv6)
LAN Prefix:	<input type="radio"/> Stateless

- **LAN Prefix**
- **LAN IPv6 Address Range** (*start and end*)
- **LAN IPv6 Link Local Address** (*automatically populated*)
- **Subnet ID** (*hexadecimal values e.g. 0-9, a-f*)
- **Router Advertisement Lifetime** (*minutes between 0-150*)

ROUTING

- **IPv6 Address Lifetime** (*minutes between 3-150*)
 - **Interfaces** - check one or more of the box(s) to apply IPv6 LAN settings to the selected interfaces:
 - Ethernet IPv6 Enabled
 - Wireless Access Point 1 IPv6 Enabled
 - Wireless Access Point 2 IPv6 Enabled
 - Coax IPv6 Enabled
3. After entering all appropriate IPv6 settings click Apply to have changes take effect.

DHCPv6 WAN WITH LAN IPv6 STATELESS SETTINGS:

1. To configure IPv6 LAN Stateless mode with DHCPv6 WAN, select the Stateless option on the IPv6 Configuration Control Page as shown below:

3. Specify the method to be used to assign LAN IPv6 addresses

IPv6 LAN Configuration:	<input type="text" value="Stateless"/>	▼
LAN Prefix:	2600::/64	
LAN Link-Local Address:	fe80::c	
Subnet ID:	<input type="text" value="0"/>	
Router Advertisement Lifetime:	<input type="text" value="3"/>	minutes (0-150)

2. Specify the Stateless settings to be used to assign LAN IPv6 addresses by entering the following details:
 - **IPv6 LAN Configuration** (select **Stateless** from the drop-down list) *as shown in drop-down list and page below:*

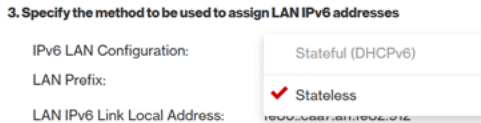

- **LAN Prefix** *(automatically populated)*
- **LAN IPv6 Link Local Address** *(automatically populated)*
- **Subnet ID** *(hexadecimal values e.g. 0-9, a-f)*
- **Router Advertisement Lifetime** *(minutes between 0-150)*
- **Interfaces** - check one or more of the box(s) to apply IPv6 LAN settings to the selected interfaces:
 - Ethernet IPv6 Enabled
 - Wireless Access Point 1 IPv6 Enabled
 - Wireless Access Point 2 IPv6 Enabled
 - Coax IPv6 Enabled

ROUTING

3. After entering all appropriate IPv6 settings click Apply to have changes take effect.

LAN IPv6 CONFIGURATION WITHOUT AN IPv6 WAN CONNECTION:

1. To configure IPv6 to use either the IPv6 LAN Stateful or Stateless mode without using an IPv6 Internet WAN connection, select the **None** option on the IPv6 Configuration Control Page as shown below:

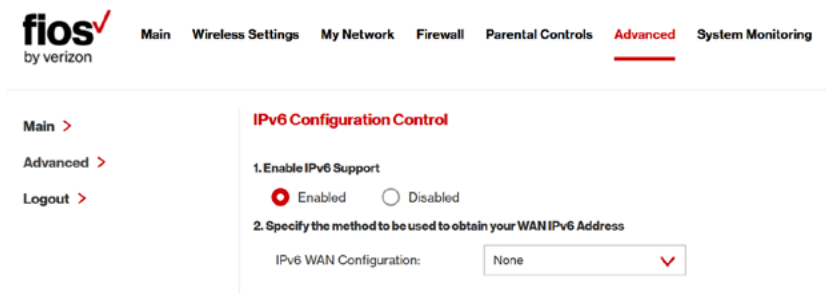

2. After entering all appropriate IPv6 settings click Apply to have changes take effect.

LAN IPv6 STATEFUL (DHCPv6) WITH NO WAN SETTINGS:

1. To configure IPv6 LAN Stateful mode with No WAN connection, select the Stateful option on the IPv6 Configuration Control Page as shown below:

The screenshot shows the Fios Advanced Settings page. The navigation bar includes: Main, Wireless Settings, My Network, Firewall, Parental Controls, **Advanced**, and System Monitoring. The left sidebar has: Main >, Advanced >, and Logout >. The main content area is titled "IPv6 Configuration Control" and contains the following sections:

- 1. Enable IPv6 Support**
 Enabled Disabled
- 2. Specify the method to be used to obtain your WAN IPv6 Address**
IPv6 WAN Configuration:
- 3. Specify the method to be used to assign LAN IPv6 addresses**
IPv6 LAN Configuration:
LAN IPv6 Address Range: -
LAN Link-Local Address: fo80::ca:ff:fe02::1c
Router Advertisement Lifetime: minutes (0-150)
- Interfaces**
 - Ethernet IPv6 Enabled
 - 5.0GHz Wireless Access Point 1 IPv6 Enabled
 - 2.4GHz Wireless Access Point 2 IPv6 Enabled
 - Coax IPv6 Enabled

At the bottom are "Apply >" and "Cancel >" buttons.

2. Specify the **Stateful (DHCPv6)** settings to be used to assign LAN IPv6 addresses by entering the following details:
 - **IPv6 LAN Configuration** (select **Stateful** from the drop-down list) as shown in drop-down list and page below:

This close-up shows the "3. Specify the method to be used to assign LAN IPv6 addresses" section. The "IPv6 LAN Configuration:" label is next to a drop-down menu that is open, showing "Stateful (DHCPv6)" selected with a red checkmark, and "Stateless" as an alternative option. The "LAN Prefix:" label is visible below the menu.

ROUTING

- **LAN IPv6 Address Range** (*start and end*)
 - **LAN IPv6 Link Local Address** (*automatically populated*)
 - **Router Advertisement Lifetime** (*minutes between 0-150*)
 - **Interfaces** - check one or more of the box(s) to apply IPv6 LAN settings to the selected interfaces:
 - Ethernet IPv6 Enabled
 - Wireless Access Point 1 IPv6 Enabled
 - Wireless Access Point 2 IPv6 Enable
 - Coax IPv6 Enabled
3. After entering all appropriate IPv6 settings click Apply to have changes take effect.

LAN IPv6 STATELESS WITH NO WAN SETTINGS:

1. To configure IPv6 LAN Stateless mode with No WAN connection, select the Stateless option on the IPv6 Configuration Control Page as shown below:

3. Specify the method to be used to assign LAN IPv6 addresses

IPv6 LAN Configuration:

LAN Link-Local Address: fe80::ca27:aff:fe62:4efc

Router Advertisement Lifetime: minutes (0-150)

Interfaces

- Ethernet IPv6 Enabled
- 5.0GHz Wireless Access Point 1 IPv6 Enabled
- 2.4GHz Wireless Access Point 2 IPv6 Enabled
- Coax IPv6 Enabled

2. Specify the **Stateless** settings to be used to assign LAN IPv6 addresses by entering the following details:

- **IPv6 LAN Configuration** (select **Stateless** from the drop-down list) as shown in drop-down list and page below:

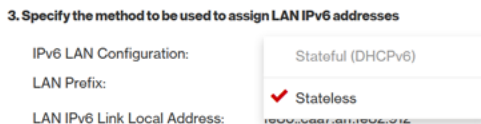

- **LAN IPv6 Link Local Address** (*automatically populated*)
 - **Router Advertisement Lifetime** (*minutes between 0-150*)
 - **Interfaces** - check one or more of the box(s) to apply IPv6 LAN settings to the selected interfaces:
 - Ethernet IPv6 Enabled
 - Wireless Access Point 1 IPv6 Enabled
 - Wireless Access Point 2 IPv6 Enable
 - Coax IPv6 Enabled
3. After entering all appropriate IPv6 settings click Apply to have changes take effect.

8.4b/ ROUTING SETTINGS

You can view the routing and IP address distribution rules as well as add, edit, or delete the rules.

ROUTING

To view the rules:

1. Select **Routing** in the Advanced page.

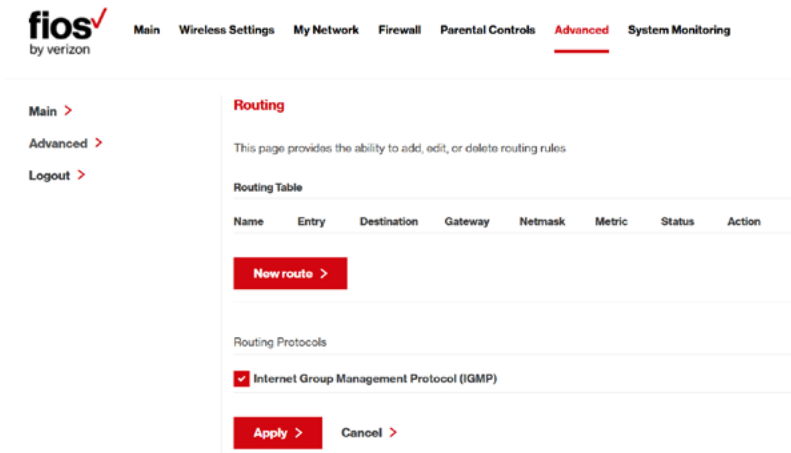

The screenshot shows the fios by verizon Advanced page. The navigation menu includes Main, Wireless Settings, My Network, Firewall, Parental Controls, **Advanced**, and System Monitoring. The left sidebar has links for Main, Advanced, and Logout. The main content area is titled "Routing" and contains the following elements:

- A description: "This page provides the ability to add, edit, or delete routing rules"
- A "Routing Table" section with a table header: Name, Entry, Destination, Gateway, Netmask, Metric, Status, Action. Below the header is a red button labeled "New route >".
- A "Routing Protocols" section with a checked checkbox for "Internet Group Management Protocol (IGMP)". Below this is a red "Apply >" button and a "Cancel >" link.

2. To add a new Gateway, click **Add New Route**.

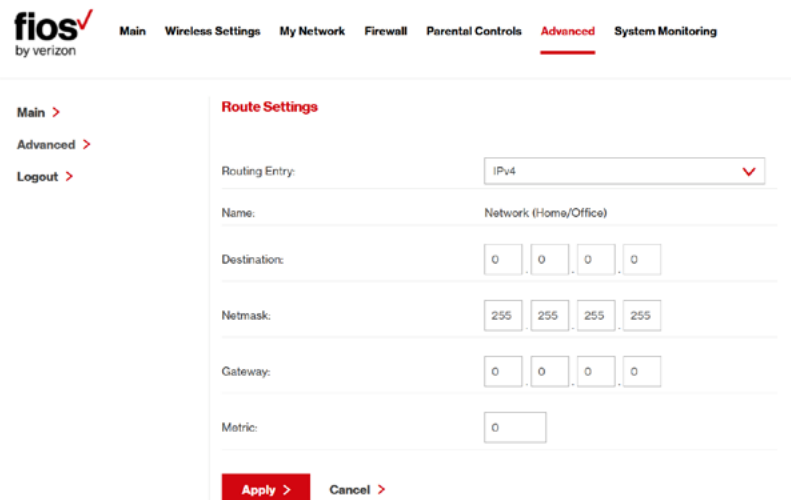

The screenshot shows the fios by verizon Advanced page with the "Route Settings" form. The navigation and sidebar are the same as in the previous screenshot. The "Route Settings" form includes the following fields:

- "Routing Entry": A dropdown menu set to "IPv4".
- "Name": A text field containing "Network (Home/Office)".
- "Destination": A text field with four input boxes containing "0", "0", "0", and "0".
- "Netmask": A text field with four input boxes containing "255", "255", "255", and "255".
- "Gateway": A text field with four input boxes containing "0", "0", "0", and "0".
- "Metric": A text field containing "0".
- At the bottom, there is a red "Apply >" button and a "Cancel >" link.

3. Specify the following parameters:
 - **Name** – select the network type.
 - **Destination** - enter the destination IP of the destination host, subnet address, network address, or default route. The destination for a default route is 0.0.0.0.
 - **Netmask** – enter the network mask. This is used in conjunction with the destination to determine when a route is used.
 - **Gateway** – enter the IP address of your Gateway.
 - **Metric** – enter a measurement preference of the route. Typically, the lowest metric is the most preferred route. If multiple routes exist to a specific destination network, the route with the lowest metric is used.
 - **Routing Entry** – select the routing entry, IPv4 or IPv6 (if enabled)
4. Click **Apply** to save changes.

8.4c/ IP ADDRESS DISTRIBUTION

You can easily add computers configured as DHCP clients to the network. The DHCP server provides a mechanism for allocating IP addresses to these hosts and for delivering network configuration parameters to the hosts.

For example, a client (host) sends a broadcast message on the network requesting an IP address for itself. The DHCP server then

ROUTING

checks its list of available addresses and leases a local IP address to the host for a specific period of time and simultaneously designates this IP address as taken. At this point, the host is configured with an IP address for the duration of the lease.

The host can renew an expiring lease or let it expire. If it renews a lease, the host receives current information about network services, as it did during the original lease, allowing it to update its network configurations to reflect any changes that occurred since the first connection to the network.

If the host wishes to terminate a lease before its expiration, it sends a release message to the DHCP server. This makes the IP address available for use by other hosts.

The DHCP server performs the following functions:

- Displays a list of all DHCP host devices connected to your Gateway
- Defines the range of IP addresses that can be allocated in the network
- Defines the length of time the dynamic IP addresses are allocated
- Provides the above configurations for each network device and can be configured and enabled or disabled separately for each network device
- Assigns a static lease to a network computer to receive the same IP address each time it connects to the network, even if this IP address is within the range of addresses that the DHCP server may assign to other computer

- Provides the DNS server with the host name and IP address of each computer connected to the network

To view a summary of the services provided by the DHCP server:

1. Select **IP Address Distribution** in the Advanced page.

The screenshot shows the Fios by Verizon Advanced settings page. The navigation menu includes Main, Wireless Settings, My Network, Firewall, Parental Controls, **Advanced**, and System Monitoring. The left sidebar has links for Main, Advanced, and Logout. The main content area is titled "IP Address Distribution" and contains a table with the following data:

Name	Service	SubnetMask	Dynamic IP Range	Action
Network (Home/Office)	DHCP Server	255.255.255.0	192.168.1.2-192.168.1.254	Edit

At the bottom of the table, there are two buttons: "Connection list" and "Close".

DHCP SERVER SETTINGS

You can edit the DHCP server settings for a device.

To edit the settings:

1. On the IP Address Distribution page, click the **Edit** icon in the **Action** column. The DHCP Settings page opens with the device information displayed.

ROUTING



- Main >
- Advanced >
- Logout >

DHCP Settings for Network (Home/Office)

Service

IP Address Distribution:

DHCP Server

Start IP Address:

End IP Address:

WINS Server:

Lease Time in Minutes:

IP Address Distribution According to DHCP Option 60 (Vendor Class Identifier)

Vendor Class ID	IP Address	MAC Address	QoS

- To enable the DHCP server, select **DHCP Server** in the **IP Address Distribution** field.

Once enabled, the DHCP server provides automatic IP assignments (IP leases) based on the preset IP range defined below.

- To configure the DHCP server complete the following fields:
 - Start IP Address** – enter the first IP address that your Gateway will automatically begin assigning IP addresses from. Since your Gateway’s default IP address is 192.168.1.1, the default start IP address should be 192.162.1.2.

- **End IP Address** – enter the last IP address that your Gateway will automatically stop the IP address allocation. The maximum end IP address range that can be entered is 192.168.1.254.
- **WINS Server** – determines the IP address associated with a network device.
- **Lease Time in Minutes** – assigns the amount of time in minutes that each device is assigned an IP address by the DHCP server when it connects to the network.

When the lease expires, the server determines if the computer has disconnected from the network. If it has, the server may reassign this IP address to a newly-connected computer.

4. Click **Apply** to save changes.

Note: DHCP Option 60 is used to define which VCI (Vendor class identifier) on the DHCP server matches the VCI used by DHCP clients (used by client to identify itself to the DHCP server).

DHCP CONNECTIONS

You can view a list of the connections currently assigned and recognized by the DHCP server. In addition, you can add a new connection with a fixed IP address.

Note: The fixed IP address of a device is assigned to the MAC address of the network card installed on the network computer. If this network card is replaced, you must update the device entry in the DHCP Connections list with the MAC address of the new network card.

ROUTING AND DATE AND TIME

To view a list of computers:

1. On the IP Address Distribution page, click **Connection List**.

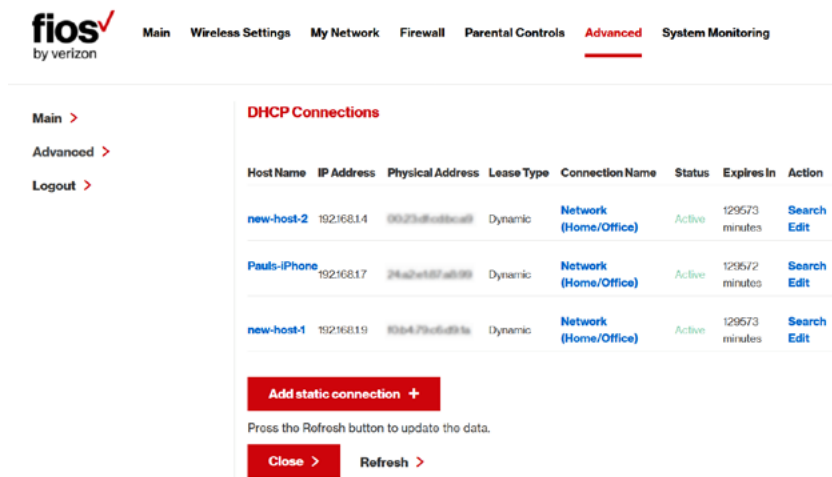

The screenshot shows the fios by verizon interface. The navigation bar includes: Main, Wireless Settings, My Network, Firewall, Parental Controls, **Advanced**, and System Monitoring. The left sidebar has: Main >, Advanced >, and Logout >. The main content area is titled "DHCP Connections" and contains a table with the following data:

Host Name	IP Address	Physical Address	Lease Type	Connection Name	Status	Expires In	Action
new-host-2	192.168.1.4	00:23:8d:ed:bc:a8	Dynamic	Network (Home/Office)	Active	129573 minutes	Search Edit
Pauls-iPhone	192.168.1.7	28:ac:2e:18:7a:b:99	Dynamic	Network (Home/Office)	Active	129572 minutes	Search Edit
new-host-1	192.168.1.9	83:b4:79:bc:d8:3a	Dynamic	Network (Home/Office)	Active	129573 minutes	Search Edit

Below the table is a red button "Add static connection +". Below that is the text "Press the Refresh button to update the data." and two red buttons: "Close >" and "Refresh >".

2. To define a new Static Connection with a fixed IP address, click **Add Static Connection**.

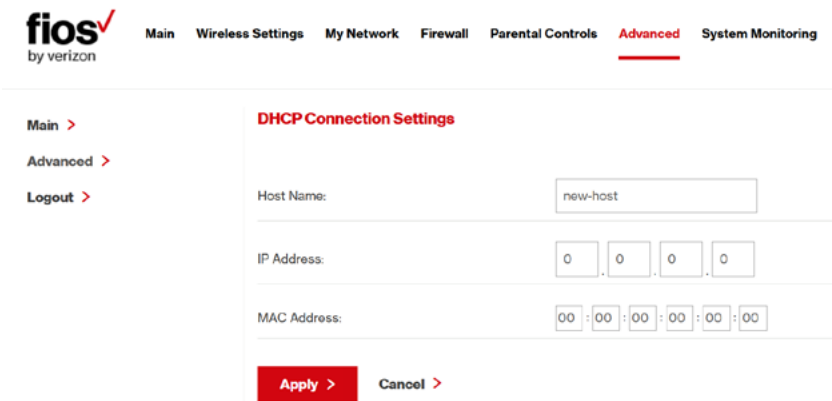

The screenshot shows the fios by verizon interface. The navigation bar includes: Main, Wireless Settings, My Network, Firewall, Parental Controls, **Advanced**, and System Monitoring. The left sidebar has: Main >, Advanced >, and Logout >. The main content area is titled "DHCP Connection Settings" and contains the following form fields:

Host Name:

IP Address:

MAC Address:

At the bottom are two red buttons: "Apply >" and "Cancel >".

3. Enter the host name.
4. Enter the fixed IP address to be assigned.
5. Enter the MAC address of the network interface of the computer used with this DHCP static connection.
6. Click **Apply** to save changes.

8.5/ DATE AND TIME

You can configure the following settings:

- **Date and Time Settings** – sets the time zone and enables automatic time updates.
- **Scheduler Rules** – limits the activation of firewall rules to specific time periods.

8.5a/ DATE AND TIME SETTINGS

You can set the time zone and enable automatic time updates.

To configure the settings:

1. Select **Date and Time** in the Advanced page.

DATE AND TIME



- Main >
- Advanced >
- Logout >

Date and Time

Localization

Local Time: Oct 03, 2017 19:33:36

Time Zone: Eastern_Time

Automatic Time Update

Enabled

Protocol: Network Time Protocol (NTP)

Time Server Action

0.north-america.pool.ntp.org [Edit Remove](#)

1.north-america.pool.ntp.org [Edit Remove](#)

[Add +](#)

Status: Got time update from server. Last update: Tue Oct 03 18:53:10 2017

Press the Refresh button to update the status.

[Apply >](#) [Cancel >](#) [Clock set >](#) [Refresh >](#)

2. Select the local time zone. Your Gateway automatically detects daylight saving times for selected time zone.
3. In the **Automatic Time Update** section, select the **Enabled** check to perform an automatic time update.
4. Define the time server addresses by clicking **Add**. The Time Server Settings page displays.

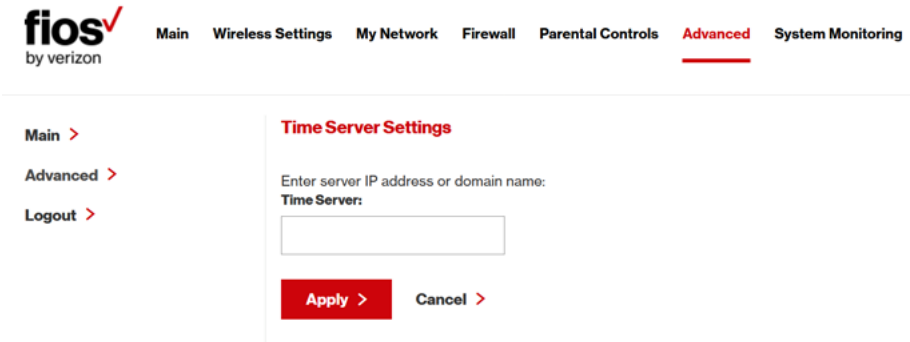

The screenshot shows the Fios by Verizon website interface. At the top, there is a navigation menu with the following items: Main, Wireless Settings, My Network, Firewall, Parental Controls, **Advanced** (highlighted with a red underline), and System Monitoring. On the left side, there is a sidebar menu with the following items: Main >, **Advanced >**, and Logout >. The main content area is titled "Time Server Settings" in red. Below the title, there is a text prompt: "Enter server IP address or domain name:". Underneath this prompt is a label "Time Server:" followed by an empty text input field. At the bottom of the form, there are two buttons: a red "Apply >" button and a "Cancel >" button.

5. Enter the IP address or domain name of the time server, then click **Apply** to save changes.

8.5b/ SCHEDULER RULES

Scheduler rules are used for limiting the activation of firewall rules to specific time periods. The time periods are either for days of the week or for hours of each day based on activity or inactivity.

To define a rule:

1. Verify that the date and time of your Gateway is correct.
2. Select **Scheduler Rules** in the Advanced page.

DATE AND TIME

The screenshot shows the Verizon Fios Advanced settings page. The navigation bar includes: Main, Wireless Settings, My Network, Firewall, Parental Controls, **Advanced**, and System Monitoring. On the left sidebar, there are links for Main >, Advanced >, and Logout >. The main content area is titled "Scheduler Rules" and contains a descriptive paragraph: "Scheduler rules are used for limiting the activation of firewall rules to specific time periods, either for days of the week, or for hours of each day". Below this is a table with columns: Rule Name, Settings, Status, and Action. The table lists two rules: "Scheduler Rule Sample 1" (Inactive) and "Scheduler Rule Example 2" (Active). At the bottom of the table area, there is a red "Add +" button, and below that, "Close >" and "Refresh >" buttons.

Rule Name	Settings	Status	Action
Scheduler Rule Sample 1	Mon, Tues, Wed, Thurs, Fri, Sat, and Sun between 12:00-01:00 on the next day Wed, and Sat between 02:00-05:00	Inactive	Edit Remove
Scheduler Rule Example 2	Tues, Thurs, Fri, and Sat between 12:00-01:00 on the next day	Active	Edit Remove

3. Click Add. The Set Rule Schedule page displays.

The screenshot shows the Verizon Fios Set Rule Schedule page. The navigation bar is the same as the previous screenshot. The left sidebar has links for Main >, Advanced >, and Logout >. The main content area is titled "Set Rule Schedule" and features a "Rule Name" input field containing "Scheduler Rule Example 3". Below this is the "Rule Settings" section with two radio button options: "Rule will be Active at the Scheduled Time" (selected) and "Rule will be Inactive at the Scheduled Time". At the bottom, there is a table with columns "Rule Schedule" and "Action". Below the table area, there is a red "Add rule schedule +" button, and at the very bottom, "Apply >" and "Cancel >" buttons.

4. Enter the name of the rule.
5. In the **Rule Settings** section, specify if the rule is active at the scheduled time or inactive at the scheduled time.
6. Click the **Add Rule Schedule**. The Edit Rule Schedule page displays.

fios
by verizon

Main Wireless Settings My Network Firewall Parental Controls **Advanced** System Monitoring

Main >
Advanced >
Logout >

Edit Rule Schedule

Days of Week

Monday

Tuesday

Wednesday

Thursday

Friday

Saturday

Sunday

Hours Range

Start	End	Action
-------	-----	--------

[New Hours Range Entry](#)

Apply > Cancel >

7. Select the active or inactive days of the week.
8. To define a new active or inactive hourly range, click **New Hours Range Entry**.

DATE AND TIME AND CONFIGURATION SETTINGS

9. Enter the start and end time, then click **Apply** to save changes.
10. Click **Apply** again to save the rule schedule.

8.6/ CONFIGURATION SETTINGS

You can configure the following configuration settings:

- **System Settings** – configures various system and management parameters
- **Port Configuration** – sets up Ethernet ports

8.6a/ SYSTEM SETTINGS

You can configure various system and management parameters.

To configure system settings:

1. Select **System Settings** in the Advanced page.

fios
by verizon

Main Wireless Settings My Network Firewall Parental Controls **Advanced** System Monitoring

Main >
Advanced >
Logout >

System Settings

Router Status

Wireless Broadband Router's Hostname:

Local Domain:

Wireless Broadband Router

Automatic Refresh of System Monitoring Web Pages

Prompt for Password When Accessing via LAN

Warn User Before Configuration Changes

Session Lifetime: Seconds

Configure number of concurrent users that can be logged into the router:

Remote Administration

Management Application Ports

Primary HTTPS Management Port:

Secondary HTTPS Management Port:

2. In the **Router Status** section, configure the following:
 - **Wireless Broadband Router's Hostname** – enter the host name or URL address of your Gateway. Both names are the same.

CONFIGURATION SETTINGS

- **Local Domain** – view or edit the local domain of the network.
3. In the **Wireless Broadband Router** section, configure the following by selecting the check box:
- **Automatic Refresh of System Monitoring Web Pages** – activates the automatic refresh of system monitoring web pages.
 - **Prompt for Password when Accessing via LAN** – causes your Gateway to ask for a password when trying to access the router’s web management GUI.
 - **Warn User Before Configuration Changes** – activates user warnings before network configuration changes take effect.

In the **Session Lifetime** field, specify the length of time required before reentering a user name and password after your Gateway has been inactive.

In the **Configure a Number of Concurrent Users** field, select the number of users that can access your Gateway at any time.

4. Select **Remote Administration** to configure the remote administration to your Gateway.
5. In the **Management Application Ports** section, change the primary and secondary HTTPS Management Ports and SSH Ports.
6. In the **System Logging** section, configure the following system log options:

- **Enable Logging** – activates system logging.
- **Remote System Notify Level** – specify the type of information, such as none, error, warning, and information, received for remote system logging.

System Logging

Enable Logging

Remote System Notify Level:

Security Logging

Remote Security Notify Level:

Auto WAN Detection

DHCP Timeout: Seconds

Apply > **Cancel** >

7. In the **Security Logging** section, configure the following security logging options:
 - **Remote System Notify Level** – specify the type of information, such as none, error, warning, and information, received for remote security logging.
8. In the **Auto WAN Detection** section, specify the DHCP timeout.
9. Click **Apply** to save changes.

CONFIGURATION SETTINGS

8.6b/ ETHERNET PORT CONFIGURATION

Ethernet port configuration allows you to set up the Ethernet ports as either full- or half-duplex ports, at either 10 Mbps, 100 Mbps, or 1000 Mbps.

To configure the ports:

1. Select **Port Configuration** in the Advanced page.

The screenshot shows the Fios by Verizon Advanced settings page. The navigation menu includes Main, Wireless Settings, My Network, Firewall, Parental Controls, **Advanced**, and System Monitoring. The left sidebar has links for Main, Advanced, and Logout. The main content area is titled "Ethernet Port Configuration" and contains a table with the following data:

Port	Speed & Duplex	Status
WAN Port	100 Full-Duplex	Connected / CRC 0
LAN Port 1	Auto	Disconnected
LAN Port 2	1000 Full-Duplex	Connected
LAN Port 3	Auto	Disconnected
LAN Port 4	100 Full-Duplex	Connected

At the bottom of the table, there are two buttons: "Apply" (highlighted in red) and "Cancel".

2. To emulate the speed and duplex configuration of the port with which it's communicating, select **Auto** or select the port speed and duplicity.
3. Click **Apply** to save changes.

09/

MONITORING YOUR GATEWAY

- 9.0** Gateway Status
- 9.1** Advanced Status
- 9.2** System Logging
- 9.3** Full Status/System Wide
Monitoring of Connections
- 9.4** Traffic Monitoring
- 9.5** Bandwidth Monitoring

MONITORING YOUR GATEWAY

System Monitoring displays system information, including basic settings, system log, key network device parameters and network traffic statistics.

9.0/ GATEWAY STATUS

You can view the basic settings of your Gateway.

To view the basic settings:

1. Select **System Monitoring** in the Main menu. The Router Status page displays.

The screenshot shows the Fios by Verizon website interface. The top navigation bar includes: Main, Wireless Settings, My Network, Firewall, Parental Controls, Advanced, and System Monitoring (which is underlined in red). On the left, a sidebar menu shows: Main >, Router Status >, Advanced Status >, and Logout >. The main content area is titled "Router Status" and displays the following information:

Firmware Version:	02.02.00.13
Hardware Version:	1.03
UI Version:	v1.0.388
Model Name:	Fios-G1100
Serial Number:	G1A11410-XXXXXXXX
Broadband MAC Address:	c8:a7:00:02:00:01
Broadband Physical Connection:	Ethernet
Broadband IPv4 Connection Status:	Connected
Connection Type:	DHCP
IPv4 Address:	71.77.255.99
Subnet Mask:	255.255.255.0
Default Gateway:	192.168.1.1
IPv4 DNS Address:	192.168.1.1, 66.256.64.12
NATs Supported (Used/Max):	24/30,000
Active Status (Router Has Been Active For):	0:12:05

At the bottom of the Router Status section, there are three buttons: a red "Close >" button, an "Automatic Refresh On >" button, and a "Refresh >" button.

GATEWAY STATUS AND ADVANCED STATUS

2. To refresh the page, click **Refresh**.
3. To continuously refresh the page, click **Automatic Refresh On**.

9.1/ ADVANCED STATUS

You can view the details and status of:

- **System Logging**
- **Full Status/System wide Monitoring of Connections**
- **Traffic Monitoring**
- **Bandwidth Monitoring**

To view the advanced status:

1. Select **Advanced Status**. A warning page displays.
2. Click **Yes**. The Advanced Status page displays.



Main Wireless Settings My Network Firewall Parental Controls **Advanced** System Monitoring

- Main >
- Router Status >
- Advanced Status >
- Logout >

Advanced Status

Click on the link you wish to view

NOTE: Only advanced technical users should use this feature.

[System Logging](#)

[Full Status/System wide Monitoring of Connections](#)

[Traffic Monitoring](#)

[Bandwidth Monitoring](#)

3. To view the details of the listed monitoring options, click the link.

9.2/ SYSTEM LOGGING

System logging provides a view of the most recent activity of your Gateway. In addition, you can view additional logs, such as the security, advanced, firewall, WAN, DHCP, and LAN DHCP.

To view the system log:

1. In the Advanced Status page, click the **System Logging** link.

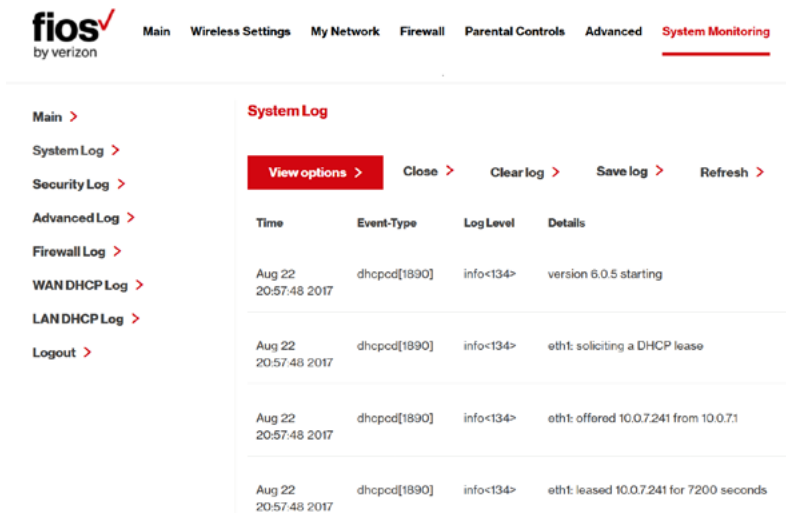

The screenshot shows the Fios by Verizon interface. The top navigation bar includes links for Main, Wireless Settings, My Network, Firewall, Parental Controls, Advanced, and System Monitoring (which is highlighted with a red underline). On the left side, there is a vertical menu with links for Main, System Log, Security Log, Advanced Log, Firewall Log, WAN DHCP Log, LAN DHCP Log, and Logout. The main content area is titled "System Log" and contains a table of log events. Above the table are buttons for "View options", "Close", "Clear log", "Save log", and "Refresh".

Time	Event-Type	Log Level	Details
Aug 22 20:57:48 2017	dhcpod[1890]	info<134>	version 6.0.5 starting
Aug 22 20:57:48 2017	dhcpod[1890]	info<134>	eth1: soliciting a DHCP lease
Aug 22 20:57:48 2017	dhcpod[1890]	info<134>	eth1: offered 10.0.7.241 from 10.0.73
Aug 22 20:57:48 2017	dhcpod[1890]	info<134>	eth1: leased 10.0.7.241 for 7200 seconds

2. To view a specific type of log event such as Security Log, WAN DHCP Log, etc., click the appropriate link in the menu in the left column.

SYSTEM LOGGING AND FULL STATUS/ SYSTEM WIDE MONITORING OF CONNECTIONS

3. To update the data, click Refresh.

9.3/ FULL STATUS/SYSTEM WIDE MONITORING OF CONNECTIONS

You can view a summary of the monitored data collected for your Gateway.

To view your Gateway's full system status:

1. In the Advanced Status page, click **Full Status/System wide Monitoring of Connections**.

The screenshot shows the 'fios by verizon' logo and a navigation menu with the following items: Main, Wireless Settings, My Network, Firewall, Parental Controls, Advanced, and System Monitoring (highlighted with a red underline). On the left side, there is a sidebar with links: Main >, Router Status >, Advanced Status >, and Logout >. The main content area is titled 'Full Status/System wide Monitoring of Connections' and contains a table with the following data:

Name	Network (Home/Office)	Broadband Connection (Ethernet/Coax)	5.0GHz Wireless Access Point 1	2.4GHz Wireless Access Point 2	Ethernet	Coax
Status	Connected	Connected	Connected	Disconnected	Connected	Cable Disconnected
Network	Network (Home/Office)	Broadband Connection	Network (Home/Office)	Network (Home/Office)	Network (Home/Office)	Network (Home/Office)
Underlying Device	5.0GHz Wireless Access Point 1	2.4GHz Wireless Access Point 2	Ethernet	Coax		
Connection type	Bridge	Ethernet/Coax	Wireless 802.11 5.0GHz Access Point	Wireless 802.11 2.4GHz Access Point	Hardware Ethernet Switch	Hardware MoCA

2. To modify the connection properties, click the individual connection links.

3. To refresh the page, click **Refresh**.
4. To continuously refresh the page, click **Automatic Refresh On**.

9.4/ TRAFFIC MONITORING

Your Gateway continually monitors traffic in the local area network and between the local network and the Internet. You can view up to the second statistical information about data received from and transmitted to the Internet as well as data received from and transmitted to computers in the local network.

To view the traffic monitoring data:

1. In the Advanced Status page, select **Traffic Monitoring**.

The screenshot shows the Fios System Monitoring interface. The top navigation bar includes: Main, Wireless Settings, My Network, Firewall, Parental Controls, Advanced, and System Monitoring (highlighted with a red underline). The left sidebar contains: Main >, Router Status >, Advanced Status >, and Logout >. The main content area is titled "Traffic Monitoring" and displays a table with the following data:

Name	Network (Home/Office)	Broadband Connection (Ethernet/Coax)	5.0GHz Wireless Access Point 1	2.4GHz Wireless Access Point 2	Ethernet	Coax
Status	Connected	Connected	Connected	Connected	Connected	Cable Disconnected
Network	Network (Home/Office)	Broadband Connection	Network (Home/Office)	Network (Home/Office)	Network (Home/Office)	Network (Home/Office)
Underlying Device	5.0GHz Wireless Access Point 1	2.4GHz Wireless Access Point 2	Ethernet	Coax		

TRAFFIC MONITORING AND BANDWIDTH MONITORING

2. To refresh the page, click **Refresh**.
3. To continuously refresh the page, click **Automatic Refresh On**.

9.5/ BANDWIDTH MONITORING

You can view and monitor the recorded bandwidth usage measured in Kbps.

To view the bandwidth:

1. In the Advanced Status page, select **Bandwidth Monitoring**.

The screenshot shows the fios by verizon System Monitoring page. The navigation menu includes Main, Wireless Settings, My Network, Firewall, Parental Controls, Advanced, and System Monitoring (which is highlighted). The main content area displays the Bandwidth Monitoring section with a table of data for various time intervals.

Bandwidth Monitoring									
	Last Minute	1 Minute	2 Minutes	3 Minutes	4 Minutes	5 Minutes	6 Minutes	7 Minutes	8 Minutes
Tx Rate	0 kb/s	16 kb/s	0 kb/s	0 kb/s	0 kb/s	0 kb/s	0 kb/s	0 kb/s	0 kb/s
Rx Rate	0 kb/s	88 kb/s	8 kb/s	0 kb/s	40 kb/s	0 kb/s	0 kb/s	0 kb/s	0 kb/s
Last Hour									
	1 Hour	2 Hours	3 Hours	4 Hours	5 Hours	6 Hours	7 Hours	8 Hours	
Tx Rate	0 kb/s	0 kb/s	0 kb/s	0 kb/s	0 kb/s	0 kb/s	0 kb/s	0 kb/s	0 kb/s
Rx Rate	16 kb/s	0 kb/s	0 kb/s	0 kb/s	0 kb/s	0 kb/s	0 kb/s	0 kb/s	0 kb/s

At the bottom of the table, there are three buttons: **Close**, **Automatic refresh on**, and **Refresh**.

2. To refresh the page, click **Refresh**.
3. To continuously refresh the page, click **Automatic Refresh On**.

10/

TROUBLE- SHOOTING

10.0 Troubleshooting Tips

10.1 Frequently Asked
Questions

TROUBLESHOOTING TIPS

This chapter lists solutions for issues that may be encountered while using your Gateway as well as frequently asked questions.

Note: The advanced settings should only be configured by experienced network technicians to avoid adversely affecting the operation of your Gateway and your local network.

10.0/ TROUBLESHOOTING TIPS

10.0a/ IF YOU ARE UNABLE TO CONNECT TO THE INTERNET:

- The first thing to check is whether your Gateway is powered on and it is connected to the Internet. Check the Power/Internet light on the front of the Gateway;  if it is lit a solid white color, then the Gateway itself has successfully connected to the Internet, and the problem lies elsewhere. If the Power/Internet light is red, the Gateway is on but is unable to connect to the Internet. In that case, check the WAN cable (Ethernet or Coax) connecting your Gateway to the Internet to make sure it is properly connected on both ends.
- Be sure your wireless device is within range of your Wi-Fi Gateway, move it closer to see if your connection improves.
- Check your network device's Wi-Fi settings to be sure your device's Wi-Fi is on (enabled) and that you have the correct Wi-Fi network and password (if using a Wi-Fi password) as configured on your Gateway.
- Be sure you are connecting to the correct Wi-Fi network, check to be sure you are using your Gateway's ESSID. In some cases, if using a wireless password, you may need to enter the Wi-Fi

TROUBLESHOOTING TIPS

password into your network device again to be sure your device accepts the password.

- Check to be sure you are running the latest software for your network device.
- Try turning your network device's Wi-Fi off and on and try to connect.
- If you have made any changes in your network settings and turning your network device's Wi-Fi off and on does not help, try to restart your network device.
- As a final tip you may need to turn your gateways' Wi-Fi settings from on to off, and back to on again and apply the changes.

10.0a/ ACCESSING YOUR GATEWAY IF YOU ARE LOCKED OUT

If your Gateway connection is lost while making configuration changes, a setting that locks access to your Gateway's GUI may have inadvertently been activated.

The common ways to lock access to your Gateway are:

- **Scheduler** - If a schedule has been created that applies to the computer over the connection being used, your Gateway will not be accessible during the times set in the schedule.
- **Access Control** - If the access control setting for the computer is set to block the computer, access to your Gateway is denied.

To gain access, restore the default settings to your Gateway.

10.0b/ RESTORING YOUR GATEWAY'S DEFAULT SETTINGS

There are two ways to restore your Gateway's default settings. It is important to note that after performing either procedure, all previously save settings on your Gateway will be lost.

- Using the tip of a ballpoint pen or pencil, press and hold the **Reset** button on the back of your Gateway for three seconds.
- Access the GUI and navigate to the Advanced Settings page. Select the **Restore Defaults** option. After saving your configuration, if desired, click the **Restore Defaults** button. For additional details, refer to the **Restore Defaults** section of this guide.

10.0c/ LAN CONNECTION FAILURE

To troubleshoot a LAN connection failure:

- Verify your Gateway is properly installed, LAN connections are correct, and that the Gateway and communicating network devices are all powered on.
- Confirm that the computer and Gateway are both on the same network segment.

If unsure, let the computer get the IP address automatically by initiating the DHCP function, then verify the computer is using an IP address within the default range of 192.168.1.2 through 192.168.1.254.

If the computer is not using an IP address within the correct IP range, it will not connect to your Gateway.

TROUBLESHOOTING TIPS

- Verify the subnet mask address is set to 255.255.255.0.

10.0d/ TIMEOUT ERROR OCCURS WHEN ENTERING THE URL OR IP ADDRESS

Verify the following:

- All computers are working properly.
- IP settings are correct.
- Gateway is on and connected properly.
- Gateway settings are the same as the computer.

10.0e/ FRONT LIGHTED INDICATORS

Flash Speed

- **Slow flash** – Two times per second
- **Fast flash** – Four times per second

Power/Internet Light

- **Slow flash white** – Gateway is starting
- **Solid white** – Gateway is powered on and connected to the Internet
- **Slow flash red** – Gateway has malfunctioned
- **Solid red** – Unable to connect to the Internet
- **Fast flash red** – Gateway is overheating. Please verify your Gateway is upright and has sufficient ventilation

Wireless Light

- **Solid white** – Wi-Fi is on

Additional Functions when pressing WPS button:

- **Slow flash white** – When the WPS button is pressed, the Wireless Light slowly flashes white, while waiting for a WPS device to connect. This can require up to two minutes.
- **Fast flash white** – When a device begins connecting to the Gateway using WPS, the Wireless Light fast flashes white for two seconds as establishing connection.
- **Solid white** – When a device successfully completes its WPS association to the Gateway, the Wireless Light returns to solid white.
- **Fast flash red** – If an error occurs during Wi-Fi Protected Setup, the Wireless Light flashes red rapidly for two minutes.

10.0f/ REAR LIGHTED INDICATORS

Flash Speed

- **Slow flash** – Two times per second
- **Fast flash** – Four times per second

WAN Ethernet

- **Unlit** – Indicates no Ethernet link

TROUBLESHOOTING TIPS AND FREQUENTLY ASKED QUESTIONS

- **Solid green** – Indicates a network link
- **Fast flash green** – Indicates network activity. The traffic can be in either direction.

LAN Ethernet – Upper LED

- **Unlit** – Indicates no 1 Gbps link
- **Solid green** – Indicates 1 Gbps link
- **Fast flash green** – Indicates LAN activity. The traffic can be in either direction.

LAN Ethernet – Lower LED

- **Unlit** – Indicates no 10/100 Mbps link
- **Solid green** – Indicates 10/100 Mbps link
- **Fast flash green** – Indicates LAN activity. The traffic can be in either direction.

LAN Coax

- **Unlit** – Indicates no MoCA network connection to the device
- **Solid green** – Indicates network link

WAN Coax

- **Unlit** – Indicates no link to the upstream MoCA device
- **Solid green** – Indicates network link

10.1/ FREQUENTLY ASKED QUESTIONS

10.1a/ I'VE RUN OUT OF ETHERNET PORTS ON MY GATEWAY. HOW DO I ADD MORE COMPUTERS OR DEVICES?

Plugging in an Ethernet hub or switch expands the number of ports on your Gateway.

- Run a straight-through Ethernet cable from the Uplink port of the new hub to the Gateway.

Use a crossover cable if there is no Uplink port/switch on your hub.

- Remove an existing device from the yellow Ethernet port on your Gateway and use that port.

10.1b/ HOW DO I CHANGE THE PASSWORD ON MY GATEWAY GUI?

To change the password:

1. On the Main screen, select **Advanced**, then select **Users**.
2. In the Users page, select **Admin**. The User Settings page displays.
3. In the **General** section, change the password.

FREQUENTLY ASKED QUESTIONS

10.1c/ IS THE WIRELESS OPTION ON BY DEFAULT ON MY GATEWAY?

Yes, your Gateway's wireless option is activated out of the box.

10.1d/ IS THE WIRELESS SECURITY ON BY DEFAULT WHEN THE WIRELESS OPTION IS ACTIVATED?

Yes, with the unique WPA2 (Wi-Fi Protected Access II) key that is printed on the sticker on the side of your Gateway.

10.1e/ WHICH CONNECTION SPEEDS DOES MY GATEWAY SUPPORT?

The Ethernet WAN Internet connection supports 10/100/1000 Mbps. The LAN Ethernet connections support 10/100/1000 Mbps. The 802.11ac wireless connection supports up to 1300 Mbps and the 802.11n supports up to 450 Mbps, depending on signal quality. The Coax (MoCA 2.0) connection supports 700 Mbps.

10.1f/ ARE MY GATEWAY'S ETHERNET PORTS AUTO-SENSING?

Yes. Either a straight-through or crossover Ethernet cable can be used.

10.1g/ CAN I USE AN OLDER WIRELESS DEVICE TO CONNECT TO MY GATEWAY?

Yes, your Gateway can interface with 802.11b, g, n, or ac devices. Your Gateway can be setup to handle only n wireless cards, g wireless cards, b wireless cards, or any combination of the three.

10.1h/ CAN MY WIRELESS SIGNAL PASS THROUGH FLOORS, WALLS, AND GLASS?

The physical environment surrounding your Gateway can have a varying effect on signal strength and quality. The denser the object, such as a concrete wall compared to a plaster wall, the greater the interference. Concrete or metal-reinforced structures experience a higher degree of signal loss than those made of wood, plaster, or glass.

10.1i/ HOW DO I LOCATE THE IP ADDRESS THAT MY COMPUTER IS USING?

In Windows 7, click the **Windows** button and select **Control Panel**, then click **View Network Status and Tasks**. In the next window, click **Local Area Connection**. In the Local Area Network Connection Status window, click **Details**.

On Mac OS X, open **System Preferences** and click the **Network** icon. The IP address displays near the top of the screen.

FREQUENTLY ASKED QUESTIONS

10.1j/ MY COMPUTER CANNOT CONNECT TO THE INTERNET USING MOCA. WHAT SHOULD I DO?

A computer cannot be connected directly using a coaxial cable. It must go through a MoCA bridge to connect. The bridge converts the coax (MoCA) signal to an Ethernet signal the computer can understand. The Fios Quantum Gateway has an integrated MoCA bridge.

First, check the connection and verify all cables are connected correctly. Then verify the Gateway is still connected and check the Ethernet connection to the Gateway from the computer.

10.1k/ I USED DHCP TO CONFIGURE MY NETWORK. DO I NEED TO RESTART MY COMPUTER TO REFRESH MY IP ADDRESS?

No. In Windows 7 or Windows 10, unplug the Ethernet cable or wireless card, then plug it back in.

10.1l/ I CANNOT ACCESS MY GATEWAY GUI. WHAT SHOULD I DO?

If you cannot access the GUI, verify the computer connected to your Gateway is set up to dynamically receive an IP address.

10.1m/ I HAVE A FTP OR WEB SERVER ON MY NETWORK. HOW CAN I MAKE IT AVAILABLE TO USERS ON THE INTERNET?

For a web server, enable port forwarding for port 80 to the IP address of the server. Also, set up the web server to receive that port. Configuring the server to use a static IP address is recommended.

For a FTP server, enable port forwarding for port 21 to the IP address of the server. Also, set up the web server to receive that port. Configuring the server to use a static IP address is recommended.

10.1n/ HOW MANY COMPUTERS CAN BE CONNECTED THROUGH MY GATEWAY?

Your Gateway is capable of 254 connections, but we recommend having no more than 45 connections. As the number of connections increase, the available speed for each computer decreases.

11/

SPECIFICATIONS

- 11.0** General Specifications
- 11.1** LED Indicators
- 11.2** Environmental Parameters

The specifications for your Fios Quantum Gateway are as follows.

This includes standards, cabling types and environmental parameters.

GENERAL SPECIFICATIONS

Note: The specifications listed in this chapter are subject to change without notice.

11.0/ GENERAL SPECIFICATIONS

<i>Model Number:</i>	Model: Fios-G1100
<i>Standards:</i>	IEEE 802.3x, 802.3u IEEE 802.11b/g/n/ac
<i>IP:</i>	IP versions 4 and 6
<i>MoCA:</i>	MoCA WAN: 1350 – 1675 MHz and 975 - 1025 MHz MoCA LAN: 1125 – 1225 MHz
<i>Speed:</i>	Wired WAN Ethernet: 10/100/1000 Mbps auto-sensing Wired LAN Ethernet: 10/100/1000 Mbps auto-sensing Wireless LAN: 2.4 GHz: 802.11b - up to 11 Mbps 2.4 GHz: 802.11g - up to 54 Mbps 2.4 GHz/5 GHz: 802.11n - up to 450 Mbps 5 GHz: 802.11ac - up to 1300 Mbps

<i>Cabling Type:</i>	Ethernet 10BaseT: UTP/STP Category 3 or 5 Ethernet 100BaseT: UTP/STP Category 5 Ethernet 1000BaseT: UTP/STP Category 5e
<i>Firewall:</i>	ICSA certified

11.1/ LED INDICATORS

<i>Front Panel:</i>	Power/Internet, Wi-Fi
<i>Rear Panel:</i>	WAN Coax, LAN Coax, WAN Ethernet, and LAN Ethernet [4]

11.2/ ENVIRONMENTAL PARAMETERS

DIMENSIONS AND WEIGHT

Fios Quantum Gateway (unit only)

Size: 3.63" wide x 9.56" high x 8.50" deep

Weight: 1.56 lbs / 0.71 kg

Complete System (including packaging)

Size: 10.16" / 258 mm width x 3.78" / 96 mm height x 10.35" / 263 mm depth

Weight: 2.63 lbs / 1.19 kg

LED INDICATORS AND ENVIRONMENTAL PARAMETERS

<i>Power:</i>	External, 12V DC, 3.0A
<i>Certifications:</i>	FCC Part 15, UL 60950-1
<i>Operating Temperature:</i>	10° C to 40° C (50° F to 104° F)
<i>Storage Temperature:</i>	-20° C to 85° C (-4° F to 185° F)
<i>Operating Humidity:</i>	8% to 95% (non-condensing)
<i>Storage Humidity:</i>	5% to 100% (non-condensing)

12/ NOTICES

12.0 Regulatory Compliance Notices

REGULATORY COMPLIANCE NOTICES

This chapter lists various compliance and modification notices, as well as the NEBS requirements and GPL.

12.0/ REGULATORY COMPLIANCE NOTICES

12.0a/ CLASS B EQUIPMENT

This equipment has been tested and found to comply with the limits for a Class B digital device, pursuant to Part 15 of the FCC Rules. These limits are designed to provide reasonable protection against harmful interference in a residential installation. This equipment generates, uses, and can radiate radio frequency energy and, if not installed and used in accordance with the instructions, may cause harmful interference to radio communications. However, there is no guarantee that interference will not occur in a particular installation.

If this equipment does cause harmful interference to radio or television reception, which can be determined by turning the equipment off and on, the user is encouraged to try to correct the interference by implementing one or more of the following measures:

- Reorient or relocate the receiving antenna
- Increase the separation between the equipment and receiver
- Connect the equipment to an outlet on a circuit different from the one to which the receiver is connected
- Consult the dealer or an experienced radio or television technician for help

REGULATORY COMPLIANCE NOTICES

12.0b/ MODIFICATIONS

The FCC requires the user to be notified that any changes or modifications made to this device that are not expressly approved by Verizon may void the user's authority to operate the equipment.

Declaration of conformity for products marked with the FCC logo – United States only.

This device complies with Part 15 of the FCC Rules. Operation is subject to the following two conditions:

- This device may not cause harmful interference
- This device must accept any interference received, including interference that may cause unwanted operation

Note: To comply with FCC RF exposure compliance requirements, the antenna used for this transmitter must be installed to provide a separation distance of at least 31 cm from all persons and must not be co-located or operating in conjunction with any other antenna or transmitter.

For operation within the 5.15 ~ 5.25 GHz frequency range, this device is restricted to indoor environments. This device meets all the other requirements specified in Part 15E, Section 15.407 of the FCC Rules.

For questions regarding your product or the FCC declaration, contact:

Verizon

One Verizon Way
Basking Ridge, NJ 07920

Attn: FCC declaration
1-800-VERIZON (1-800-837-4966)
www.verizon.com/support

12.0c/ NEBS REQUIREMENTS

The coaxial cable screen shield must be connected to the Earth at the building entrance per ANSI/NFPA 70, the National Electrical Code (NEC), in particular Section 820.93, "Grounding of Outer Conductive Shield of a Coaxial Cable," or in accordance with local regulation.

***Warning!** The WAN Coax Port is intended for connection to Verizon Fios only. It must not be connected to any exterior or interior coaxial wires not designated for Verizon Fios.*

REGULATORY COMPLIANCE NOTICES

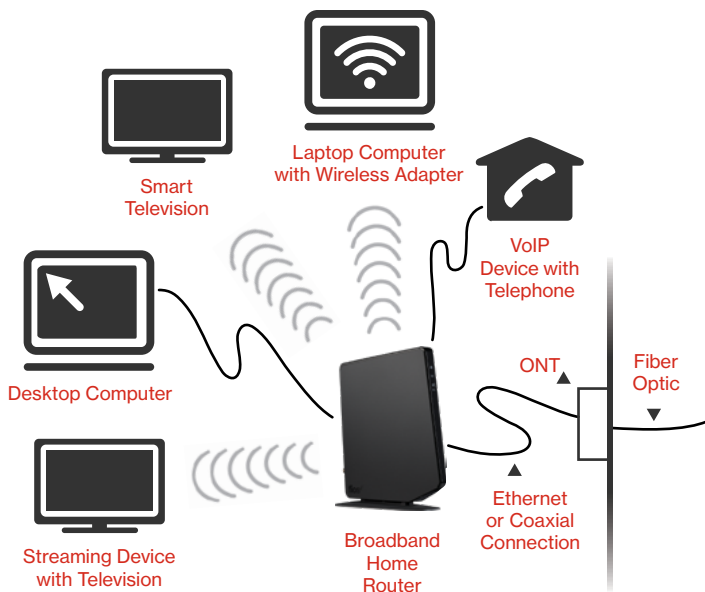

Typical Broadband Home Router Installation

Caution: The Broadband Home Router must be installed inside the home. The Router is not designed for exterior installation.

12.0d/ GENERAL PUBLIC LICENSE

This product contains certain software that is covered by open source licensing requirements. Copies of the licenses and a downloadable copy of the source code for the open source software that is used in this product are available on the following website:

<http://verizon.com/opensource/>

All open source software contained in this product is distributed **WITHOUT ANY WARRANTY**. All such software is subject to the copyrights of the authors and to the terms of the applicable licenses included in the download.

You may also obtain a copy of the source code for the open source software used in this product for a period of three years after your receipt of the product by sending a check for \$10, payable to VERIZON, to the address below:

Verizon

One Verizon Way
Basking Ridge, NJ 07920
Attn: Legal, Open Source Requests

Note: This information is provided for those who wish to edit or otherwise change such programs. You do not need a copy of any of such open source software source code to install or operate the device.

